



**An Roinn Iompair,
Turasóireachta agus Spóirt**
Department of Transport,
Tourism and Sport

TRAFFIC SIGNALS

CHAPTER 9
August 2019

Traffic Signs Manual

Chapter 9 – Traffic Signals

Contents

	<u>Page</u>
9.1 Introduction.....	3
General	3
Function Of Traffic Signals	3
Permitted Head Configurations	4
9.2 Traffic Signal Displays	5
Red/Amber/Green Signal (Rts 001)	6
Arrow And Bus Lane Signals (Rts 002)	6
Flashing Amber Arrow Signal (Rts 004)	8
Additional Aspects	9
Four-Aspect Signal Heads (Rts 003).....	9
Multiple Head Arrangements	10
Traffic Signals For Temporary Traffic Management.....	11
Regulatory Illuminated Box Signs	11
9.3 Traffic Signal Operation.....	12
Definitions	12
Modes Of Control	13
Traffic Engineering Of Signalised Junctions.....	14
Linked Systems – Types Of Utc	16
9.4 Layout Of Traffic Signals	17
High-Level Signals.....	19
Sample Junction Layouts	21
9.5 Design Of Traffic Signals	22
9.6 Visibility And Illumination.....	23
9.7 Pedestrian Signals At Signalised Junctions	24
Design Of Pedestrian Signals	25
9.8 Mid-Block (Isolated) Pedestrian Crossings	26
Conventional Crossings.....	26
Pelican Crossings.....	26
Zebra Crossings	27
Location	28
Road Markings	28
Crossing Width	29
Pedestrian Tram Crossings	29
Countdown Timers	29

9.9	Cycle Signals	30
	Shared Use Crossings.....	30
	Separate Cycle Crossings	31
	Cycle Signals At Junctions	31
9.10	Flashing Amber Signals.....	32
9.11	Level Crossing Signals	33
9.12	Tram (Light Rapid Transit).....	34
9.13	Miscellaneous	35
	Electrical Equipment.....	35
	Mounting Of Traffic Signals	35
	Appendix 9a: Permitted Traffic Signal Head Configurations	37
	Appendix 9b: Other Signalling Equipment	41
	Appendix 9c: Suggested Locations For Regulatory Box Signs	43
	Appendix 9d: Glossary.....	45
	Appendix 9e: Typical Layouts For Traffic Signals	49

9.1 Introduction

GENERAL

- 9.1.1 This Chapter provides details of the traffic signals which shall be used both at new installations or when replacing equipment at existing locations. The layout, symbols and the circumstances in which each signal may be used are specified. The Chapter should be read in conjunction with other relevant chapters. Further information on the use of the Manual is given in Chapter 1.
- 9.1.2 This Chapter does not provide instruction or guidance on the geometric design of junctions with traffic signals. Transport Infrastructure Ireland Publications¹ is the appropriate reference for this information. Additional information is also contained in the Traffic Management Guidelines².
- 9.1.3 For the purposes of this Manual:
- **Shall** or **must** indicates that a particular requirement is mandatory;
 - **Should** indicates a recommendation; and
 - **May** indicates an option.

FUNCTION OF TRAFFIC SIGNALS

- 9.1.4 Traffic signals are power operated traffic control devices displaying lights by which traffic is directed to take specific actions. They are used mainly to improve the safety of vehicle users and pedestrians and to obtain the most efficient use of available road space. All traffic signals are regulatory, except for Flashing Amber Signals (S 102), Flashing Amber Tram Signals (S 103), Tram Point Markers (S 104) and Pedestrian Countdown Timers (S 101).
- 9.1.5 The functions of traffic signals are to control traffic, cycle and pedestrian movements, particularly at intersections, and to warn road users of particular safety challenges (e.g. in advance of level crossings or schools). Traffic signals should accomplish some or all of the following objectives:
- To provide for safe and orderly movement of road users;
 - To increase the handling efficiency of a junction;

¹ Transport Infrastructure Ireland. *TII Publications*. TII, Dublin.

² Department of the Environment, Heritage and Local Government, Dublin Transportation Office and Department of Transport. *Traffic Management Guidelines*. DTTAS, Dublin.

- To reduce the frequency of accidents;
- To reduce overall delay;
- To enable traffic from minor roads to enter through routes without undue delay;
- To meet the needs of vulnerable road users;
- To facilitate the needs of public transport; and
- To promote driving comfort and convenience by simplifying decision making at complex intersections.

9.1.6 The following types of traffic signals are discussed in this Chapter:

- Signals for traffic control;
- Pedestrian crossings within signal-controlled junctions;
- Isolated (mid-block) pedestrian crossings (including pelican and toucan crossings);
- Cycle crossings;
- Flashing amber signals;
- Level crossing signals;
- Tram signals; and
- Merge ramp metering.

9.1.7 Another type of traffic signal is the Overhead Lane Control Signal, Signal RVMS 101. This is a rectangular single aspect signal which, when in operation, displays either a red cross or a green arrow. In some configurations flashing amber lamps are also deployed. This signal type is described in Chapter 3.

PERMITTED HEAD CONFIGURATIONS

9.1.8 To ensure that drivers are presented with consistent signalling throughout the country, only specified head configurations are permitted. These are itemised in Appendix 9A, and no other configurations shall be used. Section 9.2 describes in greater detail the permitted configurations and their application.

9.2 Traffic Signal Displays

9.2.1 Traffic signals are a type of signal by which traffic is alternately directed to stop and permitted to proceed. They can provide for the orderly movement of traffic and increase the traffic handling capacity of a junction, while providing improved safety for both vehicular users and pedestrians.

9.2.2 Traffic control is achieved by means of red, amber and green light signals. Each light unit is called an aspect, and a single traffic signal head shall consist of a minimum of three aspects arranged vertically and constructed in accordance with IS EN 12368³. The uppermost aspect shall always be red, and the aspect immediately beneath always amber. Heads may be supplemented by additional green or amber aspect light signals as described later in this Section and specified in Appendix 9A. The signal sequence is: red, green, amber, red (except in the case of Pelican crossings – see Section 9.8). When the red aspect is lit vehicles must not proceed past the primary traffic signal or the associated Stop Line; when the amber aspect is lit vehicles must not pass the signal or Stop Line unless they cannot safely stop in time; and when the green aspect is lit they may proceed with caution.

9.2.3 Traffic signals are switched by means of an electronic controller. The standard period during which the amber signal is displayed at intersections is fixed at three seconds. The green and red signals are shown for variable periods. If a major fault occurs the controller should either switch the traffic signals off or switch all approaches to flashing amber. Major faults are defined in IS EN 12675⁴.

9.2.4 The nominal diameter of the aspects should normally be 200mm. Existing installations may still have 300mm diameter aspects, but 200mm diameter high intensity light emitting diode (LED) aspects are now recommended. High intensity LED signals should always be used on high-speed roads. The centre of any aspect shall be not more than 380mm and not less than 240mm from that of any adjacent aspect (see Figure 9.1).

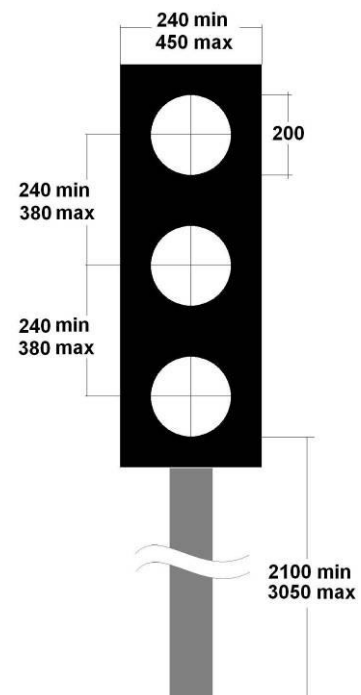

Figure 9.1: Dimensions of Standard Signal Head

³ National Standards Authority of Ireland. *IS EN 12368: Traffic Control Equipment: Signal Heads*. NSAI, Dublin.

⁴ National Standards Authority of Ireland. *IS EN 12675: Traffic Signal Controllers – Functional Safety Requirements*. NSAI, Dublin

9.2.5 For primary signals, the lower edge of the lowest aspect shall be not less than 2.1m and not more than 3.05m above the surface of the ground in the immediate vicinity. These dimensions do not apply to temporary portable traffic signals, which are described later in this Section. Further guidance on temporary signals can be found in Chapter 8. Replicated signals (e.g. secondary signals and high-level signals) shall only be provided in addition to the primary signal(s).

9.2.6 Traffic signals shall be provided with associated road markings including a Stop Line, except in the case of temporary portable traffic signals. Details of requirements for road markings are in Chapter 7, and for temporary traffic signals in Chapter 8.

RED/AMBER/GREEN SIGNAL (RTS 001)

9.2.7 The standard traffic signal (Signal RTS 001) is shown in Figure 9.2. It has three full (circular) aspects, and indicates that traffic may proceed past the associated Stop Line when directed to do so by illumination of the relevant green aspect, without imposing any restrictions as to direction, etc.



Figure 9.2: Standard Red/Amber/Green (RAG) Traffic Signal Head (RTS 001)

ARROW AND BUS LANE SIGNALS (RTS 002)

9.2.8 Signal RTS 002 permits the replacement of the full green aspect (and in some cases the full red and amber aspects) by other non-flashing aspects as described below. The full range of variants of Signal RTS 002 is illustrated in Appendix 9A.

Green Arrow Signal

9.2.9 A green arrow aspect may be substituted in place of the full green aspect, to indicate a specific movement to the left, right or straight ahead. This indicates that vehicles may proceed only in the direction indicated when the green arrow is displayed. An example is shown in Figure 9.3.

9.2.10 It should be noted that where a green arrow is used, drivers expect no conflicting movements, so it must only be used when there are no conflicting traffic or pedestrian movements in the junction.



Figure 9.3: Green Arrow Aspect Signal Head

Red/Amber/Green Arrow Signal

9.2.11 Where it is necessary to control vehicles making a particular movement (usually a right turn), a second signal head may be erected alongside the head controlling adjacent traffic movements. The second head should display red, amber and green arrows in place of full aspects (see Figure 9.4). This arrangement avoids the display of a more conspicuous full red aspect halting only turning traffic when other traffic has a green aspect. Arrows may point to the left or right, or upwards to denote a straight-ahead movement.



Figure 9.4: Red/Amber/Green Arrow Signal Head

U-Turn Arrow Signal

9.2.12 A U-Turn Arrow Signal (see Figure 9.5) may be erected in locations where a phase for U-turns is permitted but where no right turn is available (e.g. a U-turn lane on a dual carriageway where there is no side street to permit right turns).



Figure 9.5: U-Turn Signal Head

Bus Lane Signal

9.2.13 The Bus Lane 3-aspect Signal (Figure 9.6) may be used to provide separate signalling for bus lanes. It shall only be used where bus lanes or bus gates exist, and the associated Stop Line relates wholly to the movement of buses and other permitted vehicles using the bus lane, or where the bus lane signal is used to control buses and other permitted vehicles making a turning movement prohibited to general traffic (See also Paragraph 9.2.27 for the use of a single green „Bus” aspect as an additional aspect).

9.2.14 A bus gate is a signal-controlled facility usually contained within a bus lane, controlling movements in the bus lane and separated from general traffic by a traffic island – see Figure 9E10 in Appendix 9E.



Figure 9.6: Bus Lane Signal Head

FLASHING AMBER ARROW SIGNAL (RTS 004)

- 9.2.15 In Signal RTS 004 a flashing amber arrow aspect may be used in place of the full green aspect (Figure 9.7), to indicate that vehicles must yield to conflicting traffic and pedestrian movements and may only proceed if safe to do so. The arrow aspect shall only point left or right and may not be vertical.
- 9.2.16 In general, the preferred configuration will have red and amber non-flashing arrows substituted for the full red and amber aspects, and a flashing amber arrow in place of the green aspect (see Figure 9.7). Where the layout is such that the signal head is located close to a head that controls a different traffic stream, the red and centre amber arrow aspects must be used.
- 9.2.17 Full red and amber aspects should only be combined with a flashing amber arrow (see Figure 9.8) where the layout is such that the signals could not be mistaken as applying to the straight-ahead traffic, i.e. when viewed from a distance, the signal head is sufficiently offset to avoid ambiguity.
- 9.2.18 Where a flashing amber arrow is provided, either a Yield Line (RRM 018) or a Yield Sign (RUS 026) or both may be provided in accordance with Chapters 7 and 5 at the point where traffic is required to yield. A Triangular Yield Marking (M 115) may also be provided.
- 9.2.19 The full range of variants of Signal RTS 004 is illustrated in Appendix 9A.



Figure 9.7: Amber Flashing Arrow Signal Head (Preferred Configuration)



Figure 9.8: Amber Flashing Arrow Signal Head (Alternative Configuration)

ADDITIONAL ASPECTS

9.2.20 Although the above configurations are adequate for simple signalling arrangements, it is frequently necessary to display additional signals to control more complex situations. This is achieved by the use of additional aspects to supplement the standard head configurations.

9.2.21 There is a limited number of additional aspects permitted for this purpose, and there are restrictions relating to their use and positioning with respect to the main signal head. The following paragraphs detail which configurations are allowed and describe their use. A full table of all permitted configurations is given in Appendix 9A. For ease of specification, Figure 9.9 shows the numbering system used when referring to aspect locations.

9.2.22 At sites where there is limited lateral clearance certain aspects may be sited beneath the main green aspect (Location 9 in Figure 9.9). There shall be no more than four aspects arranged vertically.

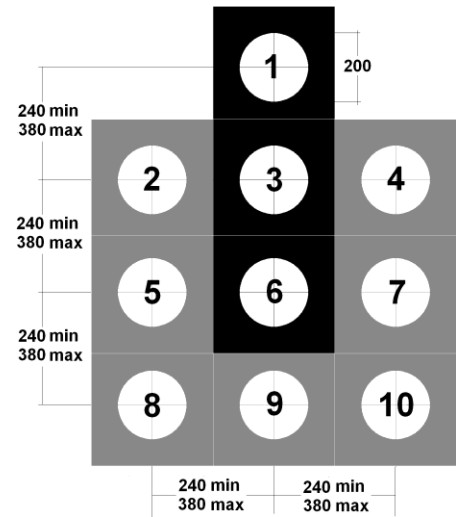

Figure 9.9: Key to Aspect Numbering

FOUR-ASPECT SIGNAL HEADS (RTS 003)

9.2.23 Four-aspect signal head assemblies are designated RTS 003. The following additional aspects are available for use:

Filter And Indicative Arrow Aspects

9.2.24 Where it is required to indicate that vehicles may proceed in a particular direction with no conflict to any traffic or pedestrian movements, an additional aspect showing a green arrow may be provided. This aspect is lit when it is safe for vehicles to proceed in the direction indicated without conflict. A typical use is to release opposed right turns across a junction when oncoming traffic has been halted (known as an indicative arrow – Figure 9.10) or to indicate a non-conflicting left turn (known as a filter arrow – Figure 9.11).

9.2.25 Indicative arrows for right turns should be restricted to sites where a substantial advantage in handling traffic can be achieved by providing additional green time for opposed turns, and pedestrian needs can be met satisfactorily under the prevailing traffic conditions. Forward visibility of oncoming traffic should be adequate.

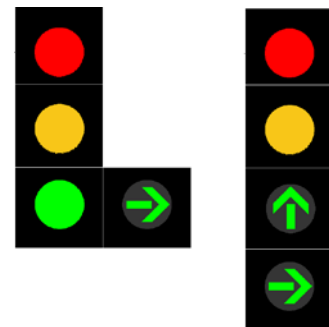

Figure 9.10: Right Turn Indicative Arrows

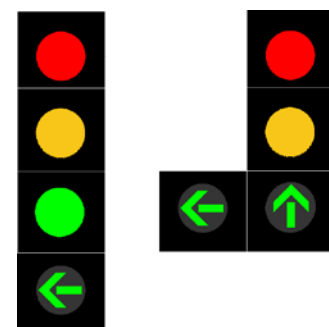

Figure 9.11: Left Turn Filter Arrows

9.2.26 Green arrow additional aspects should normally be located alongside the green aspect of the main signal head (Locations 5 or 7). The additional aspect should be sited to the left of the main green aspect where the direction of the additional green arrow aspect is to the left, and to the right when the direction is to the right. If the additional arrow is straight ahead the aspect may be placed on either side depending on site conditions. Green arrow additional aspects may be located beneath the main green aspect (Location 9) at sites with limited lateral clearance.

Bus Lane Signal Aspects

9.2.27 The single green “BUS” aspect may be used as an additional aspect to a standard red/amber/green head or red/amber/green arrow head in Locations 5 or 9 to permit separate signalling of buses.

9.2.28 The green „BUS” aspect may also be used as part of a 5-aspect head arrangement (Signal RTS 013), where an associated green arrow aspect applies to other permitted vehicles. In this case the green arrow aspect should be positioned in Location 8 and the „BUS” aspect at Location 9 as shown in Figure 9.12. The full green may be replaced with a green arrow aspect as appropriate.

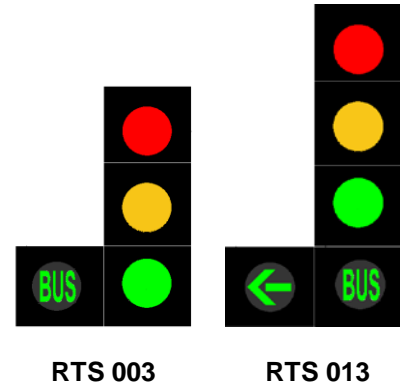

Figure 9.12: Additional Bus Lane and Left Filter Arrow Aspects

MULTIPLE HEAD ARRANGEMENTS

9.2.29 Where streams are separately signalled, it may be that heads for more than one stream have to be mounted side by side. In such cases they shall be installed such that the red, amber and green aspects align horizontally, as shown in Figure 9.13. No more than two heads (with additional aspects where appropriate) would normally be mounted in this way.

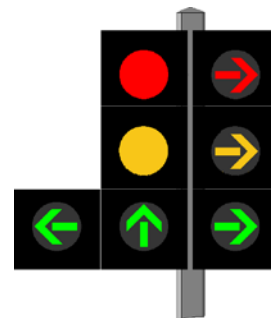

Figure 9.13: Example of Multiple Head Arrangement

TRAFFIC SIGNALS FOR TEMPORARY TRAFFIC MANAGEMENT

9.2.30 Traffic signals for temporary traffic management differ from permanent signals in that they have:

- only one primary signal;
- no secondary signal; and
- no associated road markings (Stop Line).

Additionally, the minimum mounting height is reduced to 1100mm (see Figure 9.14), although the requirements for visibility by approaching traffic shall still be observed.

9.2.31 Only the Red/Amber/Green signal head RTS 001 (standard head), RPC 004 (three aspect pedestrian signal) and RTS 007 (three aspect cycle signal) are prescribed for temporary signals. No other variants described for permanent signalling shall be used. Temporary traffic signals shall only be used where authorised. Further details are provided in Chapter 8.

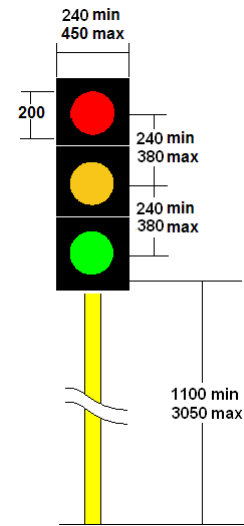

Figure 9.14: Traffic Signal for Temporary Traffic Management

REGULATORY ILLUMINATED BOX SIGNS

9.2.32 Where certain movements are prohibited at a traffic signal-controlled junction, it may be desired to provide the appropriate regulatory signing in the form of internally-illuminated “box” signs attached to the relevant signal heads. The sign faces shall be 300mm diameter and designed in accordance with Chapter 5. However, these signs may only be in addition to, and not in substitution for, larger regulatory signs. Care should be taken that the sign can be incorporated with the signal head assembly in a satisfactory manner.

9.2.33 The only signs permitted for use in such circumstances are No Right Turn (RUS 012), No Left Turn (RUS 013) and No U-Turn (RUS 017). Box signs are generally positioned in Locations 5 or 7 (or Locations 2 or 4, if 5 or 7 are occupied by additional aspects). They can also be positioned in Location 9 on a 3-aspect head with no additional aspects, or in Locations 8 or 10 when Location 9 is occupied by an additional aspect. Examples are shown in Fig 9.15. The preferred positions of the various box sign faces are given in Appendix 9C for guidance.

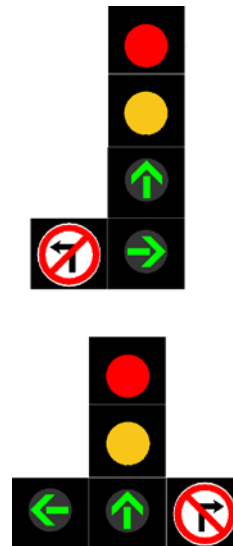

Figure 9.15: Examples of Regulatory Box Signs

9.3 Traffic Signal Operation

9.3.34 The operation of a traffic signal junction is controlled by a **controller** which allocates time intervals during which separate traffic demands for each arm of the junction can make use of the available road space. Technological advancements allow increasingly complex traffic demands to be accommodated, including pedestrians, cyclists, trams and bus priority. To avoid confusion, it is important to establish the terminology used in this manual. However, it should be noted that certain control systems may use differing terminology.

DEFINITIONS

9.3.35 A **Phase** is defined as a set of conditions which fixes the pattern of movement or waiting for one or more traffic streams during the signalling cycle. The number of phases will depend upon the number of roads entering the junction, the amount of turning traffic, the number of signalised pedestrian movements and any vehicle-specific movements. A series of phases is usually arranged in a predetermined order, but some phases may remain red if not demanded during a specific cycle. Phases are usually labelled alphabetically.

9.3.36 A **Stage** is a condition of the signal lights during the period of the cycle which gives right of way to one or more particular phases. Stages are usually labelled numerically. Staging diagrams are used to show which phases of a signal installation receive a green signal in each stage (see Figure 9.16).

9.3.37 The **Intergreen Period** is the period between the end of the green display for one stage and the start of the green display for the next stage.

9.3.38 Each repetition of the sequence of signalling operations, during which each of the demanded traffic movements are served in turn, is called a **Cycle**. In practice, cycle lengths should lie between 30 and 120 seconds, but in certain situations cycle times in excess of this may be necessary.

9.3.39 To achieve high capacity and reduce delay, as much traffic as possible should be kept moving at the same time and main traffic streams which do not conflict should be arranged to run at the same time. Careful consideration should be given to the order of stages within the cycle to maximise safety to all road users and minimise delay.

9.3.40 If a phase displays green across two or more stages, the green aspect shall be lit continuously for the duration that the phase is called.

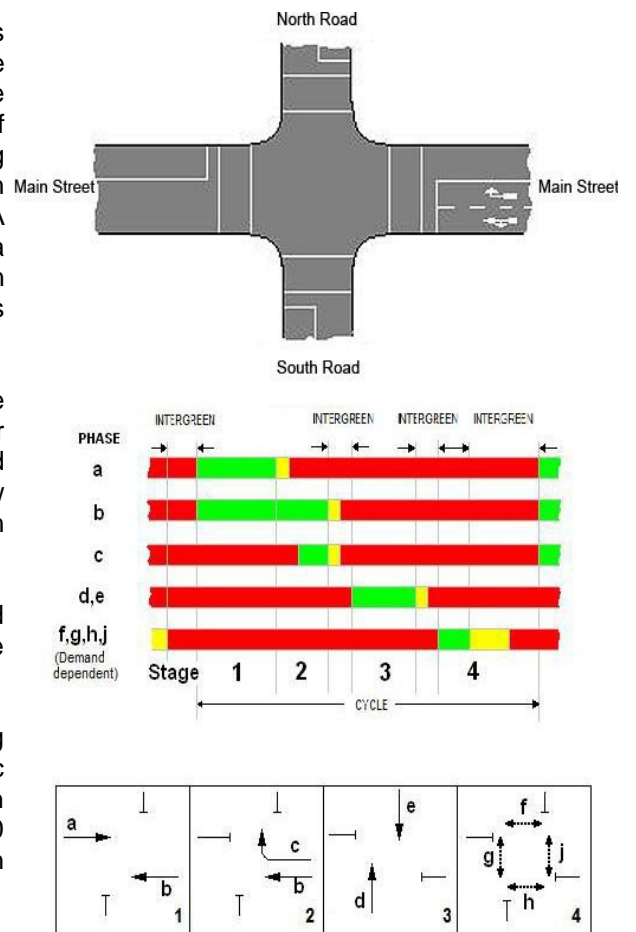

Figure 9.16:
Example of a Staging Diagram

MODES OF CONTROL

- 9.3.41 The control of traffic signals can be achieved in a number of ways:
- 9.3.42 **Fixed Time Signals:** These are signals where the green periods and hence the cycle times are predetermined and of fixed duration. Although the timings can be changed by time of day this method of control remains inflexible and would usually be used only as a fallback method.
- 9.3.43 **Vehicle Actuated Signals** are signals that use vehicle detection to register a demand for specific vehicle movements and call or extend the appropriate stage for that movement. In the absence of demands the signals will generally revert to allow the main road traffic to proceed. Vehicle actuated signals are recommended in preference to fixed time, in particular at isolated junctions.
- 9.3.44 **Isolated Adaptive (Dynamic) Control:** Adaptive control adjusts the signal timings and operation in response to real-time assessment of traffic demands on the junction. Adaptive control has been proven to give delay benefits over vehicle actuated installations.
- 9.3.45 **Linked System:** When two or more junctions are in close proximity on a main traffic route, some form of linking is advisable to reduce delays and to improve co-ordination. This will also ensure that internal links are used to the maximum effect without blocking. Linking may be:
- Cableless;
 - Cable linked; or
 - Radio linked.
- Linked systems are recommended in urban situations to maximise the performance of the traffic signals.
- 9.3.46 All controllers should have the facility to allow **Manual Control**. This may be used by engineers carrying out maintenance or adjustments to the signals, either remotely or by the Garda in the event of an incident.
- 9.3.47 **Urban Traffic Control (UTC):** Traffic signal installations in a wide area can be controlled by a central computer coordinating the individual signal controllers for each junction or crossing. Signal timings are adjusted by the computer using traffic plans generated by historical data. Older UTC systems may operate on fixed time plans, but more recent installations tend to be adaptive or dynamic systems which respond automatically to variations in pedestrian and traffic demand.

- 9.3.48 **Integrated (Strategic) Traffic Management** provides a platform for the integration of individual systems and control tools through the exchange of information between them via a common database. Integrated traffic management allows for a wider range of communication systems to be used and provides a common interface between the systems.

TRAFFIC ENGINEERING OF SIGNALISED JUNCTIONS

- 9.3.49 Opposing streams of traffic are managed at signal-controlled junctions by holding certain streams stationary while others are allowed to pass. A traffic signal installation should reduce the delay, maximise the capacity and maintain a high degree of safety. This can be achieved by assigning different stages to conflicting movements (e.g. right turn on full green), by restricting movements (e.g. banned right turn) or by the separation of traffic streams which conflict. The following facilities are available on signal installations to assist with traffic control:
- 9.3.50 **Minimum Green and Vehicle Extension Periods:** The minimum green period is the shortest period given to any phase allowing particular traffic streams to move while all others are held. It is long enough for vehicles waiting between the detector and the Stop Line to get into motion and clear the Stop Line. The minimum value is 6 seconds, except for indicative arrow or filter arrow stages which may be less. The minimum green period may be extended by vehicles which are detected during the green period.
- 9.3.51 **Preset and Variable Maximum Running Period:** To prevent vehicles on a halted phase from waiting indefinitely because of a continuous stream of traffic on a conflicting phase, a maximum period is timed off, after which the signals change even if extensions are still sought on the conflicting movement.
- 9.3.52 **Variable Intergreens:** The intergreen period can be varied by vehicle actuation when a longer clearance is necessary to protect clearing traffic. Extra clearance is thus provided only when vehicles are clearing the junction. These can be extendable intergreen periods using detection but are additional to the normal period. Variable intergreens are generally used to clear right turning traffic and to protect pedestrian phases.
- 9.3.53 **Speed Measurement:** Where appropriate, speed measurement may be required at traffic signals on roads with an 85th percentile approach speed equal to or greater than 60km/h.

- 9.3.54 **Early Cut Off:** To facilitate a heavy right turn movement from one approach, the green time of the conflicting opposing stream can be terminated a few seconds earlier, and the right turning movement given an indicative arrow signal. The duration of the early cut-off period can readily be adjusted by detectors operated by the turning traffic and will also be influenced by the junction geometry such as extended distances between stop lines and conflict points.
- 9.3.55 **Early start:** As an alternative to an early cut off, an early start displays an indicative arrow whilst delaying the start of the opposing traffic.
- 9.3.56 **Hurry Call:** The ability to call, either by selective vehicle detection or manually, a specific stage in the cycle. Hurry calls are often used for implementing bus priority at signals, or to initiate a „green wave“ for emergency services.
- 9.3.57 **Separately Signalled Right Turns:** At a crossroads where both right turn movements from the main road are heavy, the right turns can be held on a red signal while the straight-ahead traffic proceeds on green. The straight through traffic is then stopped and the right turn traffic on both approaches is then released simultaneously. This must be achieved by separating right turn traffic into exclusive lanes with separate signal displays for each approach. This method should be used on all roads where the 85th percentile approach speed is greater than 70km/h on any arm of the junction, provided the space is available.
- 9.3.58 **Revertive All Red Stage (Quiescent All Red):** The standard revertive stage is generally the main road stage. However, an all red stage may be used instead. The purpose of using an all red stage is to dissuade drivers approaching a junction from speeding up to „catch“ a green signal. If the signals rest in an all red stage when there is no demand from any approach (generally overnight when the traffic is light) then an approaching vehicle will see a red signal and slow down. The signals will respond quickly to detection and change to green on that approach. A quiescent all-red stage can only be used where detection is installed.

LINKED SYSTEMS – TYPES OF UTC

- 9.3.59 UTC is generally used in an urban situation to control a group of two or more junctions which are closely linked, normally less than 200m apart. The junction controllers are sent instructions (known as forces) from the central UTC computer, which initiates stage changes locally. These forces cannot override the local controller safety measures such as intergreens or prohibited stage changes but influence the controller.
- 9.3.60 **Fixed Time UTC:** Base fixed time plans are input to the central computer and are usually based on timings derived from a traffic model. Plans can be changed via the UTC computer automatically by time of day or manually by UTC operators. Fixed time UTC has fixed cycle times, but is capable of using demand dependent stages, such as pedestrian stages, and can also use detection on the ground. For fixed time UTC to work effectively the base plans need to be carefully calculated and require regular updates to remain efficient.
- 9.3.61 **Adaptive UTC** responds automatically to traffic fluctuations, based on data collected from detectors at every signal installation within a network. Adaptive UTC models the real time traffic patterns throughout the network and attempts to minimise the overall delay in the network by constantly changing the phase and cycle timings at each junction and modifying offset times between adjacent signal installations.

9.4 Layout of Traffic Signals

- 9.4.1 This section provides general guidance on the layout of traffic signal-controlled junctions.
- 9.4.2 The main considerations for traffic signal installation placement are visibility and clarity. Drivers approaching a signalised junction should be given a clear and unmistakable indication of which directions they can take at that junction. There should be at least one primary and one secondary signal provided for each approach. In addition, they should be guided in advance into the correct lane by means of road markings.
- 9.4.3 In the design of a traffic signal installation consideration should be given to inter-visibility between conflicting traffic streams, especially if signalled pedestrian facilities are to be included.
- 9.4.4 The normal range of lane widths at a signal-controlled junction should be between 3.0m and 3.7m depending on the type and speed of traffic and the overall width of the carriageway. The width may need to be adjusted to allow for additional lanes for straight through and turning traffic having regard to the total width available. The absolute minimum lane width of 2.4m is allowable alongside refuges at signals and at the Stop Line but nowhere else.
- 9.4.5 Where possible, refuges and islands should have a Keep Left sign (RUS 001) facing oncoming traffic, mounted in illuminated or retro-reflective bollards or on short posts (see Chapter 1). On some islands, Keep Right (RUS 002) or Pass Either Side (RUS 003) may be appropriate (see Chapter 5).
- 9.4.6 The distance from the kerb edge and any part of a signal head assembly should not normally be less than 350mm to prevent damage from lateral overhang of vehicles.
- 9.4.7 **Primary signals** are traffic signals erected on or near the carriageway in the vicinity of the Stop Line, facing approaching traffic. One primary signal must be provided for every controlled movement, located on the left side of the approach (except in the special case described in Paragraph 9.4.11). On wide approach roads with refuges or a central reserve, or on high-speed roads, the primary signal should be supplemented by a duplicate primary signal on the refuge or reserve. On one-way streets a duplicate primary signal should always be provided. They should be aligned such that their axes focus on a point in the centre of the approach lane(s) at a distance from the Stop Line equivalent to the visibility distances given in Table 9.1 (see Figure 9.17 and Section 9.6).

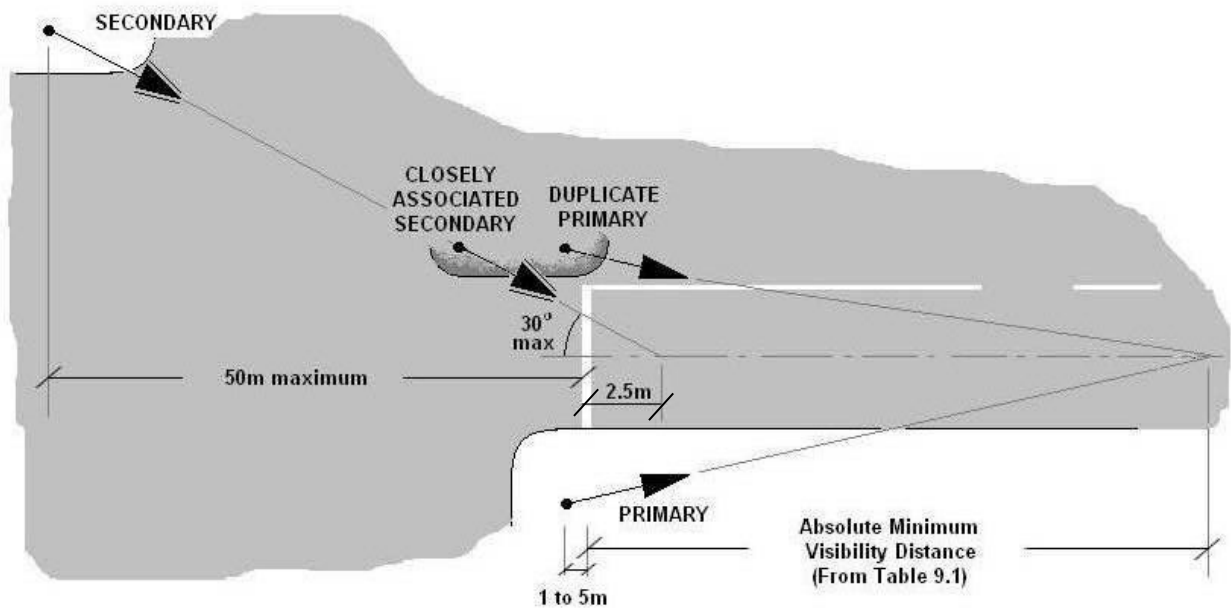

Figure 9.17:

Example of Positions and Alignments of Primary and Secondary Signals

- 9.4.8 **Secondary signals** are traffic signals erected on or near the carriageway facing traffic in the same direction as the primary signals and generally sited on the right side of the road beyond the junction. They are often placed on the back of the primary signal which faces opposing traffic. On roads with refuges or a central reserve the secondary signal should be sited on the further refuge or reserve, if it will then be more conspicuous to traffic. Secondary signals should be aligned such that their axes focus on a point 2.5m back from the associated Stop Line in the centre of the approach lane(s) (See Figure 9.17).
- 9.4.9 Secondary signal displays must not conflict with the primary display and should be sited such that it is clear to which traffic movement they refer. Hoods and/or louvres may be used to restrict visibility by adjacent streams.
- 9.4.10 The primary signal should normally be located 1m to 5m beyond the Stop Line on the left side of the approach. The secondary signal should be sited no more than 50m from the associated Stop Line, and as close to the driver's line of sight as practicable. However, they may be displaced to right or left such that they are within 30° of the line of sight (see Figure 9.17).
- 9.4.11 Where two approaches share a common Stop Line and are not separated by an island, the primary signal for the right-hand approach may have to be placed on the right side of that approach.

9.4.12 In certain circumstances, such as when an early cut-off is used, it may not be desirable to site the secondary signal beyond the junction on a particular approach. On these occasions, closely associated secondary signals may be used to prevent pedestrians or certain streams of traffic seeing the secondary signal. Closely associated secondary signals are positioned on the entry side of the junction beyond the Stop Line on the right of the traffic stream.

HIGH-LEVEL SIGNALS

9.4.13 Where standard height primary signals cannot be located to provide the required visibility to drivers on the approach given in Table 9.1 (due to a crest in the road or a building, for example), additional primary signals may be located on high mast poles, mast-arms or overhead gantries.

9.4.14 Support structures for high-level signals will generally be more massive than conventional street furniture. Consideration must therefore be given to the potential need for safety barriers on high-speed roads.

9.4.15 LED aspects should be used for all mast-arms, gantries and high mast poles to reduce the maintenance frequency and consequent impact on traffic.

Mast Arms and Gantries

9.4.16 High-level signal heads must be supplementary to a primary signal head mounted on the left side of the road at the prescribed height. This may be free standing or mounted on the support structure if it is within 5 metres of the associated stop line.

9.4.17 Mast arm mountings (see Figure 9.18) have single support poles, with outreaches between 3m and 7m in length, depending upon the number of signals and outreach required for visibility.

9.4.18 For gantries, mast arms or any other mounting of signal heads above the carriageway, the head(s) shall be mounted on the gantry or arm, located directly above the lane(s) to which they relate. A new construction headroom (which allows an allowance for future resurfacing) of 5.7m shall be provided from the lowest point of any part of the assembly; and a minimum maintained headroom of 5.41m shall be preserved at all times.

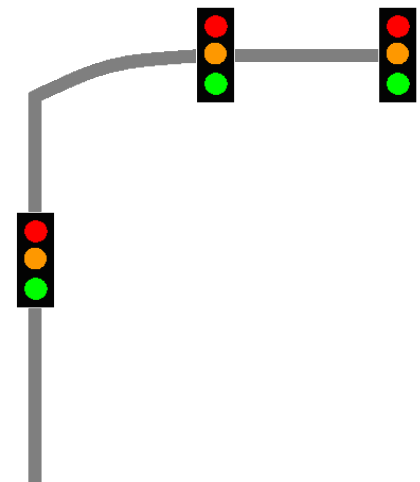

Figure 9.18:
Example of Mast Arm Mounting

High Mast Poles

- 9.4.19 Where signal heads are to be mounted at high level on high mast poles, these should be supplementary to an identical signal head mounted at the prescribed height on the pole.
- 9.4.20 The high-level head on a high mast pole shall be mounted such that the centre of the amber aspect is no higher than 5m above the surface of the ground in the immediate vicinity (see Figure 9.19).

CONTROLLER LOCATION

- 9.4.21 The signal controller cabinet should be positioned so that it does not obstruct the drivers' view of pedestrians, particularly children, beginning to cross and it should cause minimum obstruction on the footway. Should it be necessary to site the controller adjacent to the kerb, then it should not be possible for the access doors to open over the carriageway. When the doors are open they should not completely block the footway.
- 9.4.22 In addition, the cabinet should be sited at a location where the complete function of the signals is visible to assist an operator when the signals are under manual control or being tested.

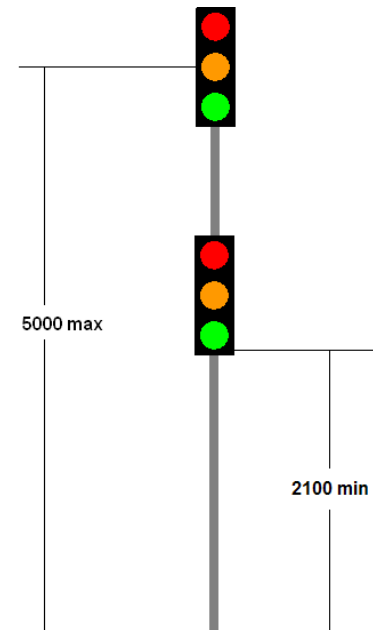

Figure 9.19: Example of High Mast Pole Mounting

SAMPLE JUNCTION LAYOUTS

9.4.23 Sample layouts for junctions, mid-block crossings and other signal installations are contained in Appendix 9E for the purpose of demonstrating signal head provision, siting and alignment. They should be read in conjunction with the following notes:

- i. The drawings are not drawn to scale. Guardrailing, detection equipment, ducting, advanced cycle stop lines and tactile paving have been omitted for clarity.
- ii. For details of road markings see Chapter 7.
- iii. For signal symbols used see Appendices 9A and 9B.
- iv. Primary signals should normally be located 1m to 5m beyond the Stop Line on the left side of the approach. Where a pedestrian facility is located immediately beyond a Stop Line, this distance should ideally be a minimum of 2.5m.
- v. Secondary signals should be sited no more than 50m from the associated Stop Line, and as close to the driver's line of sight as practicable.
- vi. In general, there should be one more signal head per stream (primary + secondary) than there are lanes on that stream.
- vii. Signalised pedestrian facilities should be provided along the desire lines of pedestrian flow. Judicious use of refuges can permit certain pedestrian movements to run simultaneously with non-conflicting traffic movements. This is termed „walk with traffic“ and can have a beneficial effect on junction capacities.
- viii. The width of pedestrian crossings should normally be between 2.4m and 5m, although in exceptional circumstances they may be reduced to 2m or increased to a normal maximum of 10m (see Section 9.8). Where cycles share a crossing, the crossing width should be 4m minimum.
- ix. Pedestrian demand units should be mounted approximately 0.4m to 0.5m from the pedestrian crossing line and sited such that a pedestrian pressing the button is facing towards oncoming traffic. On one-way streets, at staggered crossings or in other situations where this causes the demand unit to be located to the left of crossing pedestrians, a duplicate demand unit should be located to the right.

9.5 Design of Traffic Signals

- 9.5.1 To obtain the maximum benefits from the provision of traffic signal control, it is essential that they be installed in accordance with uniform criteria.
- 9.5.2 The following data is required to enable the need for traffic signals to be assessed properly and the design of the signals to be carried out:
- (a) Traffic Volumes. Pedestrian and vehicular directional counts over a ten-hour period of a representative day on each approach;
 - (b) Approach Speeds. 85th percentile speed of vehicles on each approach. This is the speed exceeded by only 15% of cars in dry weather, which can be measured by accepted speed survey methods;
 - (c) Site Conditions. These should include approach widths, gradients, speed limits and approach visibility distances; and
 - (d) Accident History.
- 9.5.3 At high-speed locations where posts and other signalling equipment may be vulnerable to collision, consideration should be given to reduce the risk to road users of such collisions. This can include resiting equipment, provision of safety kerbs and/or safety barriers, and the use of passively safe signal poles.
- 9.5.4 The details of the final design of signals systems are outside the scope of this document.

9.6 Visibility and Illumination

9.6.1 The main consideration for traffic signal installation placement is visibility. Drivers approaching a signalised junction should be given a clear and unmistakable indication of which directions they can take at that junction. Signal faces should be adjusted to face the approaching traffic for which they are intended.

9.6.2 The minimum visibility distances, with no traffic present, required to the primary signal(s) are shown in Table 9.1. Wherever possible the „Desirable Minimum” distance should be provided. However, site considerations may make these distances unattainable, in which case the „Absolute Minimum” value may be used.

9.6.3 In the table, reference to „speed” shall be interpreted as follows:

- i. On new or improved roads, „speed” is the Design Speed, calculated in accordance with TII Publication DN-GEO-03031⁵, or the speed limit;
- ii. In the case of existing roads, „speed” is the speed limit, except when there is a significant difference between the speed limit and actual vehicle speeds, in which case:
- iii. „Speed” is the observed 85th percentile approach speed of private cars. This is the speed which is exceeded by only 15% of cars in dry weather and may be measured by accepted speed survey methods.

Table 9.1 Visibility Distances

Speed (see Paragraph 9.6.3) km/h	Visibility Distance to Primary Signal	
	Desirable Minimum m	Absolute Minimum m
30	50	40
50	70	50
60	90	70
70	120	90
80 or 85	160	120
100	215	160
120	Not recommended	

9.6.4 LED signals should be used for all new installations because they are brighter than conventional filament lamps, have a longer life, use less energy, require less maintenance, and are safer because of their reliability. Each aspect shall conform to IS EN 12368. Mixtures of different types of aspect (filament, fibre-optic, LED) within an installation should be avoided.

9.6.5 Where ambient light conditions affect the illumination of traffic signals (due to sunlight for example), hoods, louvres and/or backboards may be fitted. Hoods or louvres may also be used to prevent signals being seen by drivers waiting on adjacent arms of the junction. For high-speed roads the use of backboards should be considered, to increase the conspicuity of signal heads.

⁵ Transport Infrastructure Ireland. DN-GEO-03043, *Road Link Design*. Part of TII Publications. TII, Dublin.

9.7 Pedestrian Signals at Signalised Junctions

- 9.7.1 The information contained in this section shall apply to all new installations or complete replacement of equipment at existing locations.
- 9.7.2 Pedestrian signals are traffic signals intended for the exclusive purpose of controlling pedestrian traffic. Pedestrian facilities should be provided to improve the safety of pedestrians crossing roads. They are often included at junctions with traffic signal control. For mid-block pedestrian crossings, see Section 9.8.
- 9.7.3 Pedestrians are catered for by providing a phase for pedestrians where their movements are signalised. This pedestrian phase is best activated by demand from push buttons but can be activated automatically if the circumstances justify it (for example to prevent phases getting out of step with adjacent signals on linked signal systems).
- 9.7.4 Three-Aspect Pedestrian Signals, Signal RPC 004, consist of three aspects depicting:
- A figure of a standing figure in red on a black background;
 - A figure of a standing figure in amber on a black background;
 - A figure of a walking figure in green on a black background.
- The use of two-aspect pedestrian signals is restricted to Pelican and Toucan Crossings only – see Section 9.8.
- 9.7.5 The red aspect shall be located above the amber, and the amber aspect above the green. The nominal minimum diameter of the aspects should be 200mm and the centres of adjacent aspects should be not more than 380mm apart. The lower edge of the lowest aspect should be between 2.1m and 3.05m above the surface of the ground in the vicinity.
- 9.7.6 The pedestrian signal sequence is red figure, green figure, amber figure, red figure. The amber figure signal indicates that pedestrians should not start to cross. The duration of the green figure signal, which indicates that pedestrians may start to cross the road, shall be based on the time to cross the full road width at a walking speed of 1.2m/s, and shall be a minimum of 6 seconds. An all-red period before and after the pedestrian crossing phase shall be a minimum of 1 second but may be increased depending on traffic speed and crossing width.



**RPC 004:
Three-Aspect Pedestrian Signal**

DESIGN OF PEDESTRIAN SIGNALS

- 9.7.7 In many cases the only way of providing pedestrian signals within a signal-controlled junction will be by holding all vehicle streams on red (referred to as an „all-red“). This can result in a significant reduction in junction capacity. However, by prohibiting some vehicle movements or, where space permits, by physically separating traffic streams, it is possible to economise on cycle time by running a combination of vehicle and pedestrian stages simultaneously. This can maximise green time in the cycle by negating the need for an „all red“. Such pedestrian facilities, known as parallel pedestrian phases or „walk with traffic“, should be carefully designed to avoid confusion to traffic or pedestrians.
- 9.7.8 On wide carriageways refuges may be provided in the centre of the carriageway. Where the two parts of the crossing are controlled by separate pedestrian signals, the pedestrian crossings should be staggered, and the pedestrian signals positioned and aligned so that pedestrians are not misled by the further set of signals.
- 9.7.9 Staggered pedestrian crossing facilities should be considered where the crossing distance exceeds 11m.
- 9.7.10 During stages when there is sufficient crossing time for pedestrians (with parallel traffic movements), the green figure should be displayed without requiring the push button to be activated. However, when an extension to the phase is required to allow pedestrians to cross, this should only be activated by a pedestrian pushing the push button unit.
- 9.7.11 Complementary measures to assist visually impaired pedestrians should be provided to indicate the green figure period. These include:
- Tactile signals (e.g. a textured feature on the push button which vibrates when the steady green figure is shown); and
 - Audible signals as a supplement to the tactile facility (so long as there is no danger of the unit causing confusion with adjacent signalised pedestrian crossings). Where audible signals are considered, variable output audible signals should be used in residential areas (these transmit a lower signal at night when background noise is lower).

9.8 Mid-Block (Isolated) Pedestrian Crossings

9.8.1 The facilities and design details outlined in Section 9.7 for pedestrian crossings within signalised junctions are also appropriate for mid-block pedestrian crossings. The following section describes the different forms of mid-block pedestrian crossings available for use in different scenarios and conditions.

CONVENTIONAL CROSSINGS

9.8.2 Conventional signalised pedestrian crossings include two stages: one for moving traffic (typically the default), and one for pedestrians (typically by demand from a push-button unit). They should be provided with Three-Aspect Pedestrian Signals (RPC 004) facing the pedestrians and standard full red/amber/green traffic signals (RTS 001) facing vehicles. The sequences are red figure, green figure, amber figure, red figure for pedestrians, and red, green, amber, red for vehicles.

9.8.3 Conventional crossings do not include the flashing amber signal to permit vehicles to proceed once pedestrians have crossed the road (see next paragraph).



**RPC 004:
Three-Aspect Pedestrian Signal**

PELICAN CROSSINGS

9.8.4 Pelican Crossings are crossings which control both vehicular and pedestrian traffic by light signals. They differ from conventional signalised pedestrian crossings by incorporating a Two-Aspect Pedestrian Signal (RPC 003) that displays a flashing green figure simultaneously with a red signal then flashing amber signal to vehicles, the flashing amber signal to vehicles overlapping the red to pedestrians. The two-aspect pedestrian signal shall only be used at Pelican and Toucan Crossings. At all other forms of signal-controlled pedestrian crossing the three- aspect head shall be used.

9.8.5 The signal head RPC 003 prescribed for Pelican Crossings consists of two aspects depicting:

- A figure of a standing figure in red on a black background;
- A figure of a walking figure in green on a black background.



**RPC 003:
Two-Aspect Pedestrian Signal (Pelican
and Toucan Crossings only)**

- 9.8.6 The red aspect shall be located above the green. The nominal minimum diameter of the aspects should be 200mm and the centres of the aspects should be not more than 380mm apart. The lower edge of the lowest aspect should be between 2.1m and 3.05m above the surface of the ground in the vicinity.
- 9.8.7 The pedestrian signal sequence is red figure, steady green figure, flashing green figure, red figure. The green figure flashes to indicate that pedestrians should not start to cross. The duration of the green figure signal, which indicates that pedestrians may start to cross the road, shall be based on the time to cross the full road width at a walking speed of 1.2m/s, and shall be a minimum of 6 seconds.
- 9.8.8 For vehicles, the standard full red/amber/green traffic signal (RTS 001) is used at pelican crossings, with a circular amber aspect which can be steady or flashing. The sequence is red, flashing amber, green, amber, red. The flashing amber signal indicates that vehicles may proceed if the crossing is clear. However, if there are pedestrians on the crossing, vehicles must continue to yield to them.
- 9.8.9 Pelican crossing timings are similar to the pedestrian crossing timings set out in Section 9.7. The steady green figure should be displayed for a minimum of 6 seconds. The flashing green figure shall commence 2 seconds before the flashing amber to traffic, and the red figure shall commence a minimum of 2 seconds before the green signal to traffic.
- 9.8.10 Mid-block signalised pedestrian crossings should normally be pelican crossings, unless engineering judgement indicates otherwise, for example on wide roads or locations of extremely high pedestrian activity.

ZEBRA CROSSINGS

- 9.8.11 Zebra Crossings, RPC 001, are pedestrian crossings marked by flashing amber beacons, alternate black and white stripes across the road, and other road markings. Vehicles must stop if there is a pedestrian on the crossing. They are not signalised crossings but are considered controlled crossings and are included here for completeness. Zebra crossings are not normally considered suitable for roads with a maximum speed limit greater than 50km/h, or where there is more than one lane in each direction (unless a refuge island is provided). For details of zebra crossings see Chapter 7.

9.8.12 The Pedestrian Crossing Beacon consists of an internally illuminated globe mounted on a post; it is used to indicate the presence of a priority-controlled („Zebra”) pedestrian crossing. The beacon must be provided on both sides of the road (and on refuges where present) in conjunction with the Pedestrian Crossing road markings (see Chapter 7). The combination of the beacons and road markings constitute traffic Sign RPC 001.

9.8.13 The beacon shall consist of a spherical globe approximately 300mm in diameter, yellow in colour and mounted on a post between 2.1m and 4.2m high. The beacon shall be lit internally with a flashing yellow light, flashing at between 35 and 45 flashes per minute.

LOCATION

9.8.14 A pedestrian crossing should be located where pedestrians are most likely to use it and where it does not confuse or cause conflict for vehicular movement. The minimum recommended distance between uncoordinated mid-block pedestrian crossings, or between a pedestrian crossing and an uncoordinated signal-controlled junction is 100m. Adequate footway capacity should be provided at each end of the crossing for assembly and dispersal.

9.8.15 Crossings should be located away from conflict points at uncontrolled junctions, and care should be taken when siting close to roundabouts.

9.8.16 Minimum distances for drivers' visibility of signals controlling a pedestrian crossing are the same as for other signals and are given in Table 9.1.

9.8.17 The guiding principle regarding the visibility of signals is that a driver must have a clear view of at least one signal head on approaching the crossing and when stationary at the Stop Line.

ROAD MARKINGS

9.8.18 The road markings associated with mid-block crossings are described in Chapter 7.

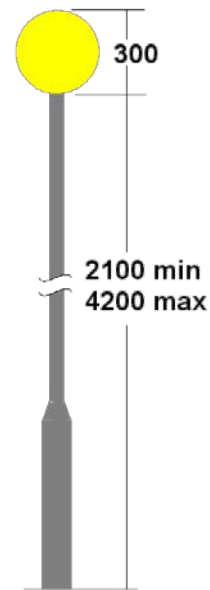

Figure 9.20: Pedestrian Crossing Beacon

CROSSING WIDTH

9.8.19 The preferred minimum pedestrian crossing width for pedestrian crossings is 2.4m (at signalised facilities at signal-controlled junctions, and at conventional, pelican and zebra crossings). This may be reduced to an absolute minimum of 2m at restricted locations. An additional 0.5m may be provided for each 125 pedestrians per hour above 600 (average over the four hours of peak pedestrian use) up to a normal maximum of 5m. However, at locations with exceptionally high pedestrian demands, it may be appropriate to provide crossings up to 10m wide.

PEDESTRIAN TRAM CROSSINGS

9.8.20 Where pedestrians have to cross a tramway and a carriageway in a single crossing movement, the usual Pedestrian Signals, RPC 004, should be provided, as described above for mid-block crossings or in Section 9.7 for signalised junctions.

9.8.21 Where a pedestrian crossing of a tramway is separate from a carriageway crossing, pedestrian signals will not normally be provided for the crossing of the tramway. In view of the relative infrequency of trams, pedestrians should have little difficulty in crossing the tramway safely.

9.8.22 However, at some locations restricted visibility or large numbers of pedestrians may create the need to provide signals warning of the approach of a tram. At such locations, Flashing Amber Tram Signals, Signal S 103, may be used. The signals consist of two flashing amber aspects indicating the outline of a tram when lit. The aspects are mounted one above the other on a black background. The aspects should be approximately 300mm in diameter and flash at a rate of 60 to 80 flashes a minute. The flashes in each light should overlap so that one light is always shown when in operation. They should only be activated when a tram is approaching.

9.8.23 The need for Flashing Amber Tram Signals shall be assessed by the tram operating authority and the form and operation agreed with the Road Authority.

COUNTDOWN TIMERS

9.8.24 At locations where pedestrian numbers or pedestrian waiting times are high, a Pedestrian Countdown Timer, S 101, may be installed on each side of the pedestrian crossing in addition to the red, amber and green figure signals (see Figure 9.21).



S 103: Flashing Amber Tram Signals



S 101: Pedestrian Countdown Timer

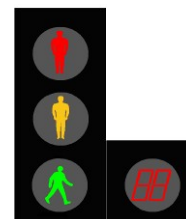
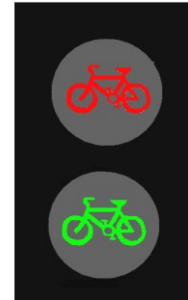

Figure 9.21: Combination of RPC 004 and S 101

9.9 Cycle Signals

9.9.25 Cycle signals are similar to pedestrian signals except that they depict bicycle symbols. They are used, either at a junction or as a mid-block crossing, to enable cyclists to cross the road safely. Cyclists are not required to dismount and cross on foot. Both Two-Aspect Cycle Signals, Signal RTS 006, and Three-Aspect Cycle Signals, Signal RTS 007, are available but their uses differ, as described below.

9.9.26 On RTS 006 the red aspect shall be placed above the green, while on RTS 007 the red aspect shall be placed above the amber and the amber aspect above the green. The nominal minimum diameter of the aspects should be 200mm with the centres of the aspects not more than 380mm apart or nominal diameter between 80mm and 110mm with the centres of the aspect not more than 150mm apart. The lower edge of the lowest aspect should be either between 2.1m and 3.05m above the surface of the ground in the vicinity for 200mm aspects, or between 1.5m and 1.7m for the 80mm to 110mm size aspects.



**RTS 006:
Two Aspect Cycle Signal**

SHARED USE CROSSINGS

9.9.27 Where there is a need for both cyclists and pedestrians to cross a road, Toucan (two-can-cross) Crossings may be installed. There are two forms available for use:

- i. Based upon the Pelican control system, i.e. two-aspect pedestrian and cycle heads, RPC 003 and RTS 006, with flashing green figure to pedestrians, flashing green bicycle to cyclists, and flashing amber to traffic. This is known as a Toucan Crossing, and is recommended for mid-block pedestrian/cycle crossings, but not at junctions under signal control; and
- ii. Three-aspect pedestrian and cycle heads, RPC 004 and RTS 007, and no flashing amber traffic aspect. This is recommended for use where the cycle and pedestrian crossing facility forms part of a junction under signal control.



**RTS 007:
Three Aspect Cycle Signal**

9.9.28 In each case, the sequence for the cycle signals is the same as the associated pedestrian signals (see Sections 9.7 and 9.8).

9.9.29 The required red signal time to vehicles is determined by the pedestrian crossing time, as these are typically longer than for cyclists. Separate detection for cyclists may reduce delay time to vehicles, as cyclists will negotiate a crossing more quickly than pedestrians.

- 9.9.30 Shared use crossings should be a minimum of 4.0m wide to provide adequate width for both pedestrians and cyclists.

SEPARATE CYCLE CROSSINGS

- 9.9.31 Where a cycle crossing facility is provided with no associated pedestrian facility, the Three-Aspect Cycle Signals, RTS 007, should be used. The sequence for cyclists is red cycle, green cycle, amber cycle, red cycle.

CYCLE SIGNALS AT JUNCTIONS

- 9.9.32 Cycle crossings may be incorporated as part of a signalised junction in the same way as pedestrian crossings (see Section 9.7).
- 9.9.33 Cycle signals may also be used to provide separate control of cyclists on the carriageway through a signalised junction. In such cases, Three-Aspect Cycle Signals, RTS 007, shall be used.
- 9.9.34 Where it is not practicable to provide separately signalised cycle facilities through a junction, advance cycle Stop Lines as described in Chapter 7 should be considered as appropriate.

9.10 Flashing Amber Signals

- 9.10.1 Twin Flashing Amber Signals, Signal S 102, may be used in conjunction with the School Ahead sign (W 141), with a Periodic Speed Limit sign (RUS 045) and on approaches to railway level crossings. The signal consists of twin flashing amber lights arranged horizontally on a black background.
- 9.10.2 The signals should have a minimum diameter of 150mm, and flash at a rate of 60 to 80 flashes per minute. The flashes in each light should overlap so that one light is always shown when in operation.
- 9.10.3 It is important that the flashing amber signals be operated only at appropriate times. When used in conjunction with a School Ahead sign, the signals should only be activated at times when children are entering or leaving the school. See Chapter 6.
- 9.10.4 When used in conjunction with a Periodic Speed Limit sign, the twin flashing amber signals shall be operated only at times when the periodic speed limit applies. See Chapters 3 and 5.
- 9.10.5 These signals may also be used to provide additional warning at level crossings controlled by Level Crossing Signals, RTS 005. In such cases the twin flashing amber signals shall flash whenever the lights on RTS 005 are activated. See Chapter 6.
- 9.10.6 Flashing Amber Signals may also be used as part of a vehicle activated sign: see Chapter 3.
- 9.10.7 At some pedestrian crossings of tramways Flashing Amber Tram Signals, Signal S 103, may be provided. These indicate the outline of a tram when lit: see Section 9.8.

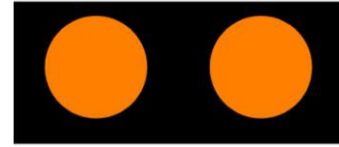

S 102: Flashing Amber Signals

9.11 Level Crossing Signals

- 9.11.8 Level Crossing Signals, Signal RTS 005, consist of two red aspects arranged horizontally and one amber aspect, centrally positioned between but lower than the two red aspects. Each aspect shall have a nominal diameter of 200mm or 300mm.
- 9.11.9 The red aspects flash alternatively when in operation, indicating vehicles must stop at the associated Stop Line or at the signal where the Stop Line is not present. The amber light is lit constantly (not flashing) for a few seconds before the red lights start flashing. It does not remain lit when the red lights are operating. The illumination of the amber aspect indicates that vehicles should stop unless too close to the signal/Stop Line to be able to stop safely.
- 9.11.10 Level Crossing Signals are normally used to control vehicular traffic and pedestrians on approaches to railway level crossings. The signals should be provided at full barrier crossings, at half barrier crossings and at lights and bells crossings. They are operated by the railway authority in conjunction with the railway signalling. See Chapter 6. They shall not be used to control tram crossings; these shall be treated as conventional signalised junctions, using conventional traffic signals for road traffic and the aspects described in Section 9.12 for trams.
- 9.11.11 RTS 005 may also be used to control pedestrians and traffic at swing or lifting bridges.
- 9.11.12 A Stop Line should accompany the Level Crossing Signals to indicate to drivers where they must stop in advance of the level crossing or bridge when the red signals are displayed: see Chapter 7.

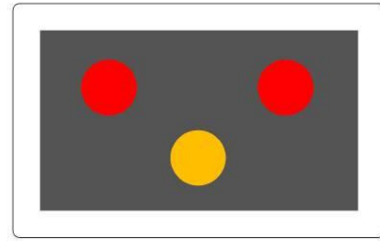

RTS 005: Level Crossing Signals

9.12 Tram (Light Rapid Transit)

9.12.13 Where trams – light rapid transit (LRT) vehicles – are running on the public road special Tram Signals are used to control them (Signals RTS 008 to RTS 012 and S 104). The signals consist of a series of lights forming a narrow white line or plus sign on a black background. Single aspect signals are used, displaying the appropriate signal when required. The design of the signals is deliberately different from signals for other road users, since they are intended only for LRT drivers.

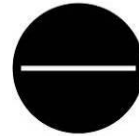

RTS 008: Tram Stop

9.12.14 Tram Signals will often operate in conjunction with traffic signals controlling road traffic. In some instances, they may be programmed to give a different instruction to tram drivers from that given to other drivers. For example, a tram may be permitted to proceed while road traffic in adjacent lanes is stopped by a red signal.

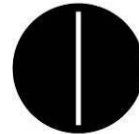

RTS 009: Tram Proceed

9.12.15 The need for Tram Signals will be determined by the tram operating authority and their size, location and operation agreed with the Road Authority in accordance with the provisions prescribed in the Road Traffic (Signs) Regulations.



RTS 010: Tram Proceed to Left

9.12.16 Flashing Amber Tram Signals, S 103, are available for warning pedestrians of approaching trams at separate pedestrian crossings of tram tracks: see Section 9.8.



RTS 011: Tram Proceed to Right



S 104L



S 104R

S 104: Tram Point Indicators



RTS 012: Tram Stop Unless Too Close to Stop Safely

9.13 Miscellaneous

9.13.17 A detailed specification is required for the supply and erection of all traffic signals and associated equipment. This specification should include the following considerations:

ELECTRICAL EQUIPMENT

9.13.18 Aspects shall conform to IS EN 12368. As part of the Government's climate change strategy, the use of low energy equipment should be implemented wherever possible, for example LED aspects, low energy controllers, etc. It is possible to have some equipment (for example S 102) powered by solar cells – this option should be considered wherever feasible.

9.13.19 LED aspects should be used for all new signal installations, and particularly for signals mounted on mast-arms, overhead gantries and tall signal poles.

9.13.20 The controller specification should be agreed with the Road Authority and may depend upon the type of Urban Traffic Control System to be used (if required).

9.13.21 All new traffic signal controllers should have the capacity to dim the signals overnight to reduce glare for drivers.

MOUNTING OF TRAFFIC SIGNALS

9.13.22 Consideration should be given to minimising the number of poles at junctions

9.13.23 Traffic signal poles need to be of sufficient length to enable the signal heads to be set at the required height (see Section 9.2). The following heights (above ground) are commonly used:

- i. 4m – standard pole height;
- ii. 5.5m – allows one signal to be mounted at a standard height plus another at a higher level (i.e. two signals) for extra visibility. Sometimes used on dual carriageways;
- iii. 1.25m – to accommodate push button units for pedestrians only;
- iv. 5.5m mast arm support columns.

9.13.24 Clearances for over-carriageway mounting are discussed in Section 9.4.

Appendix 9A: Permitted Traffic Signal Head Configurations

Permitted traffic signal head configurations are defined in the Road Traffic (Signs) Regulations using the following numbering logic: RTS 001 is the basic Red/Amber/Green head; RTS 002 covers all other 3-aspect heads *without* flashing amber arrows; RTS 003 are all 4-aspect heads; RTS 004 are all 3-aspect heads *with* flashing amber arrows; RTS 013 is a 5-aspect bus and filter arrow configuration.

The following diagrams illustrate all permitted traffic signal head configurations, together with the standard symbols that should be used to indicate those head configurations on plans. Use of these symbols provides a consistent method of annotation and prevents misinterpretation at any stage of the design and build process.

The logic of the symbols is as follows:

	A signal pole is shown as a filled circle, from which the head symbols generate.
	A primary traffic head is shown as an arrow.
	A secondary traffic head is indicated by two lines parallel to the edges of the main head arrow.
	An arrow aspect in place of the full green is indicated by a small arrow pointing in the appropriate direction, the stem of which is attached to the point of the main head arrow. (A flashing amber arrow should be annotated with the legend FA; a green arrow needs no annotation).
	Additional aspects (as defined in Section 9.2) are indicated by small arrows pointing in the appropriate direction, across the stem of the relevant traffic head arrow.
	Where all three aspects are replaced with arrows, a triple arrow is appended to the point of the main head arrow.
	A pedestrian head is shown as a semi-circle.
	A 3-aspect head is shown as a „solid“ arrow.
	A 2-aspect head is shown as a „hollow“ arrow.
	A single aspect is shown as a „chevron“ arrow.
	A pedestrian demand unit is shown as a solid triangle.
	Regulatory box signs are indicated by a rectangular box appended to the stem of the traffic head arrow, containing the numeric part of the RUS number (e.g. RUS 012 „No Right Turn“ would be signified by the number „012“).
	Louvres are indicated by a line and chevrons across the tip of the head to which they apply.

Some signal heads have annotations to define their type (for example, signals for buses or cycles have a B or C respectively). Symbols for signals mounted on mast arms or gantries, or multiple heads mounted on a single pole, are shown in the „Assemblies“ section of Appendix 9B.

Three-Aspect Traffic Signal Heads (RTS 001, RTS 002 and RTS 004)

	RTS 001	RTS 002				
Head Configuration						
Primary						
Secondary						



	RTS 002			RTS 004			
Head Configuration							
Primary							
Secondary							

Four-Aspect Traffic Signal Heads (RTS 003)





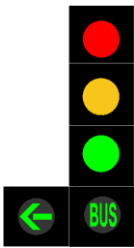
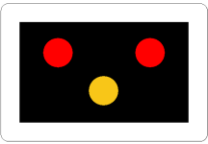

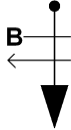
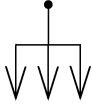
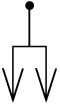

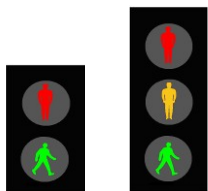

RTS 003	
Head Configuration	
Primary	
Secondary	

RTS 003	
Head Configuration	
Primary	
Secondary	

Other Traffic Signal Heads

	RTS 013	RTS 005	S 102
Head Configuration			
Primary			
Secondary	N/A	N/A	N/A

Pedestrian and Cycle Signal Heads

	RPC 003 RPC 004	RTS 006	RTS 007	S 101	S 103
Head Configuration					
Primary					



Appendix 9B: Other Signalling Equipment

Tram Signals, Pedestrian Demand Units, Detection, etc.





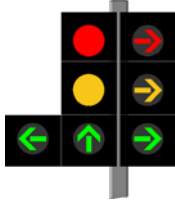
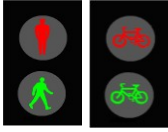

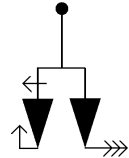
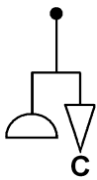
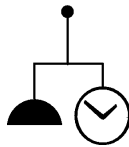
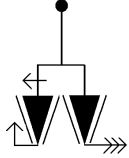



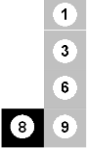

	Tram Signals RTS 008 – RTS 012 and S 104	Pedestrian Demand Units	Detection	Controller
Head Configuration			N/A	N/A
Primary				

Assemblies

	Mast Arm	Gantry	High Mast
Head Configuration			
Primary			
Secondary			

	Multiple Head Mounting	Toucan Ped/Cycle Display	Pedestrian Countdown Timer
Head Configuration			
Primary			
Secondary		N/A	N/A

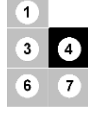
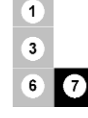
Appendix 9C: Suggested Locations for Regulatory Box Signs

 RUS 013 No Left Turn				
 RUS 012 No Right Turn				
 RUS 017 No U-Turn				

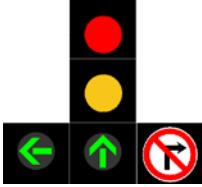
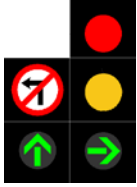
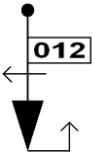
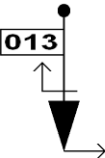
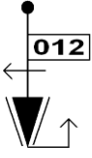
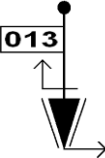
Head Configuration		
Primary		
Secondary		

Appendix 9D: Glossary

Abbreviation/Term	Meaning
All Red	A condition of traffic signals where all vehicular movements receive a red signal.
All-Red Period	Period during the change from one phase green to the next when all phases show red.
Amber	The colour in the yellow part of the spectrum used in traffic signals.
Approach	That part of an arm which carries traffic towards the junction.
Arm	One of the roads radiating from a junction.
Arrow	A signal aspect with a symbol indicating a direction.
Aspect (Signal Aspect)	A single optical unit, which, when illuminated, displays a single colour or symbol.
Audible Signal	A device producing a sound to indicate right of way to pedestrians.
Box Sign	A regulatory sign (such as a prohibited movement sign) designed to be mounted alongside a signal head.
Bus Priority	A strategy for reducing delay to buses.
Cabinet	A box installed on-street to contain a controller or other equipment.
Call	The placing of a demand for a stage or phase.
Capacity	The maximum flow that can proceed through a point in a given time.
Cableless Linking Facility (CLF)	A system for co-ordinating the timings of signal equipment at adjacent signalised junctions by the use of clocks synchronised to mains supply frequency.
Conflict	At a junction, movements which cannot proceed at the same time safely are in conflict.
Conflicting Phases	Phases which are in conflict (see „opposing phases“).
Controller	Apparatus that controls and switches traffic signals.
Cycle	One complete sequence of the operation of traffic signals.
Cycle Time	The time taken to complete one cycle.
Demand	Request for right-of-way for traffic passing a detector and approaching a red signal.
Demand Dependent	A stage in a signal cycle which is only selected when a demand for it is registered.
Detector	Unit of the vehicular or pedestrian detecting equipment that initiates a demand or extension.
Duplicate Primary Signal	A second primary signal mounted on the right-hand side of the carriageway.
Early Cut-Off	A condition in which one or more traffic streams, that were running during the preceding stage, are stopped whilst one or more other traffic streams are allowed to continue moving.

Abbreviation/Term	Meaning
Early Start	A condition in which one or more traffic streams are permitted to move before the release of other traffic streams, which are permitted to run with them during the subsequent stage.
Exit	At a junction, the portion of an arm which carries traffic away from the junction.
Extension	Continuation of the green signal that results from a request made by a vehicle or pedestrian that has priority. (May also be applied to a red signal.)
Fallback	The control strategy adopted by a control system when the preferred strategy becomes faulty.
Filter Arrow	A green arrow (generally to the left) which indicates that turning movements may proceed without conflict in the direction shown prior to the full green aspect being lit.
Fixed Time	Traffic signal control where the duration of the red and green signals and the length of the cycle is fixed.
Flashing	Intermittent operation of a signal aspect.
Flow	The rate at which vehicles pass a point.
Green	The colour of the aspect giving right of way at signals.
Green Arrow	A symbol incorporated in a green aspect to indicate permitted direction of movement.
High-Speed Road	A road where the 85th percentile approach speeds at a junction are 60km/h or above.
Indicative Green Arrow	A green arrow (generally to the right) indicating that vehicles may proceed in the direction shown without conflict with oncoming traffic.
Intergreen (Period)	Period between the end of the green signal giving right of way for one phase, and the beginning of the green signal giving right of way for the next phase.
Lamp	The light source in a signal aspect.
Lane Control Signals	Overhead signals comprising a green arrow or a red cross to indicate whether traffic is permitted in a particular lane.
Led	Light Emitting Diode.
Lens	The translucent face of a signal aspect which supplies the colour and symbol (if required) and which may control the light distribution of the aspect.
Local Control	A form of control at a signal installation which is not subject to influences from other junctions or area control systems.
Loop Detector	A detector which operates by analysing the electromagnetic effects on a buried loop of wire caused by the presence or passage of a vehicle.
Lost Time	The time during a cycle which cannot be used as effective green to one or more phases.
Maximum Green (Maximum Running Period)	The maximum time that a green signal to vehicles can continue to operate. This is normally after a demand has been made by traffic on another phase.
Mid-Block Crossing	A signalled pedestrian (or pedestrian and cycle) facility located remotely from a signal-controlled junction.

Abbreviation/Term	Meaning
Minimum Green (Minimum Running Period)	Duration of the green signal, following the extinction of a red signal, during which no change of signal lights can occur.
Movement	The traffic taking a specific route through a junction from a defined entry to a defined exit.
Offset	The difference in time between a specific point in the cycle at a junction and a reference point.
Opposed Right Turn	A right turning movement which is in conflict with oncoming traffic.
Opposing Phases	Phases which are not permitted to run together by the controller, but which do not control conflicting traffic movements (see „conflicting phases“).
Opposing Traffic	Traffic proceeding in the opposite direction.
Overlap	Phases which run in successive stages (e.g. early start, early cut-off).
Pedestrian Demand Unit	A housing containing a push button. Also known as “push button unit” or “push button box”
Pelican Crossing	A mid-block pedestrian crossing using pedestrian signals with a flashing amber/flashing green figure period during which vehicles are permitted to move subject to yielding to pedestrians (Pedestrian Light Controlled crossing).
Period	A time period in a phase during which there is no change in condition.
Phase	Sequence of conditions applied to one or more streams of traffic.
Phase Delay	The technique of staggering or aligning the start or end of one or more phases in a stage to minimise the lost time between successive stages.
Phase Diagram	A diagram showing (as horizontal lines) the sequence of conditions of each of the phases at a traffic signal junction.
Presence	A target being present within the detection zone.
Primary Signal	A signal head close to the Stop Line normally mounted on the left-hand side of the carriageway.
Push Button	A button which may be pressed to register a demand.
Queue	A stationary or slow-moving file of traffic where the progress of a vehicle is determined by that of the preceding vehicle.
Red	The colour of the aspect giving the instruction to stop.
Run	A phase is said to be running when it is displaying a green signal. A stage is said to run a phase if that phase displays a green signal during that stage.
Saturation Flow	The maximum flow (usually expressed in vehicles per hour) obtained at a Stop Line during green from a discharging queue.
Secondary Signal	A signal beyond the Stop Line which duplicates the display at the primary signal.
Serve	A demand is said to be “served” when the phase to which it relates receives right of way.
Signal Face	One or more signal heads mounted together turned towards a traffic stream.

Abbreviation/Term	Meaning
Signal Group	A group of signal heads controlled by the same phase.
Signal Head	A combination of signal aspects which together provide all the signal displays required for the control of one or more traffic streams at the same Stop Line.
Signal Plan	A set of timings for the control of a group or network of junctions.
Stage	The period within a traffic signalling cycle that gives right of way to one or more particular traffic movements. A stage starts when the last of its associated phases commences and ends when the first of its associated phases terminates.
Stage Diagram	A diagram for a signalised controlled junction showing by means of arrows those movements permitted in each of the stages.
Stop Line	A transverse road marking RRM 017 indicating where vehicles should stop when signalled to do so. See Chapter 7.
Stream (Traffic Stream)	Vehicles in one or more lanes on the same approach to the controlled area which, when they have the right-of-way, will move in the same direction.
Tactile Indicator	An indicator (typically a vibrating plate or rotating cone) which indicates the presence of a green signal for the benefit of visually impaired pedestrians.
Temporary Signal	A traffic signal using the same type of signal equipment as permanent signals, but which is installed for a limited period of time.
Toucan Crossing	A mid-block combined pedestrian/cyclist crossing (“two can cross”).
Tram Signal	A signal which controls light rail vehicles running on-street at signalised junctions.
Urban Traffic Control (Utc)	A method of controlling and managing a number of traffic signal installations from one computer system.
Variable Maximum/ Minimum Green	A feature of vehicle actuated control which allows the maximum/ minimum green timing to be varied according to traffic flow.
Vehicle Actuation	Traffic signalling strategy in which the duration of the red and green signals and the time of duration of the cycle vary in relation to the traffic demands at the controlled area. It is actuated by traffic by means of vehicle detection.
Walk with Traffic	A control system where pedestrian phases run simultaneously with non-conflicting vehicle phases.

Appendix 9E: Typical Layouts for Traffic Signals

The following Figures illustrate typical layouts for traffic signals. It should be noted that they indicate the *minimum* requirements for the given examples. Site conditions may dictate that additional signals are required. These figures should be read in conjunction with the notes in Section 9.4.

Figure	Title
9E1	T-Junction with All-Red Demand-Dependent Pedestrian Stage
9E2	Major/Minor Junction with Central Islands on Main Road
9E3	Major/Minor Junction without Central Islands
9E4	Major/Minor Junction with Separate Right Turn Lanes on Main Road
9E5	Left/Right Staggered Junction
9E6	Right/Left Staggered Junction
9E7	Staging Arrangement for Early Start, Early Cut-off and Filter
9E8	Uncontrolled Segregated Left Turn Lane
9E9	Signalised Roundabout Entry
9E10	Bus Gate
9E11	Bus Early Start at Signalised Junction
9E12	Merge Ramp Metering
9E13	Pelican Crossings
9E14	Toucan Crossing

Figure 9E1

NOTES:

- Right turning traffic from the major road into the minor road turns either through gaps in the opposing flow or at the end of Stage 2.
- Pedestrians are provided with a demand-dependent all-red stage which is called by a demand on any pedestrian demand unit.

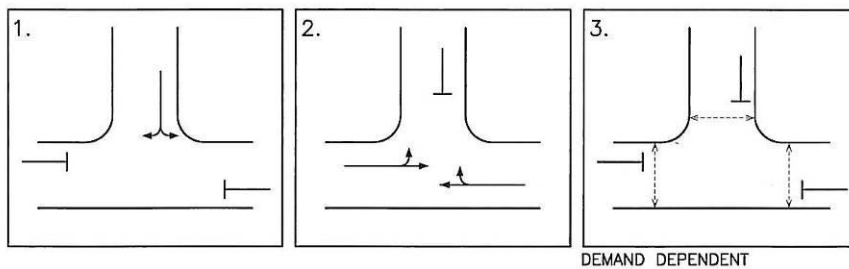
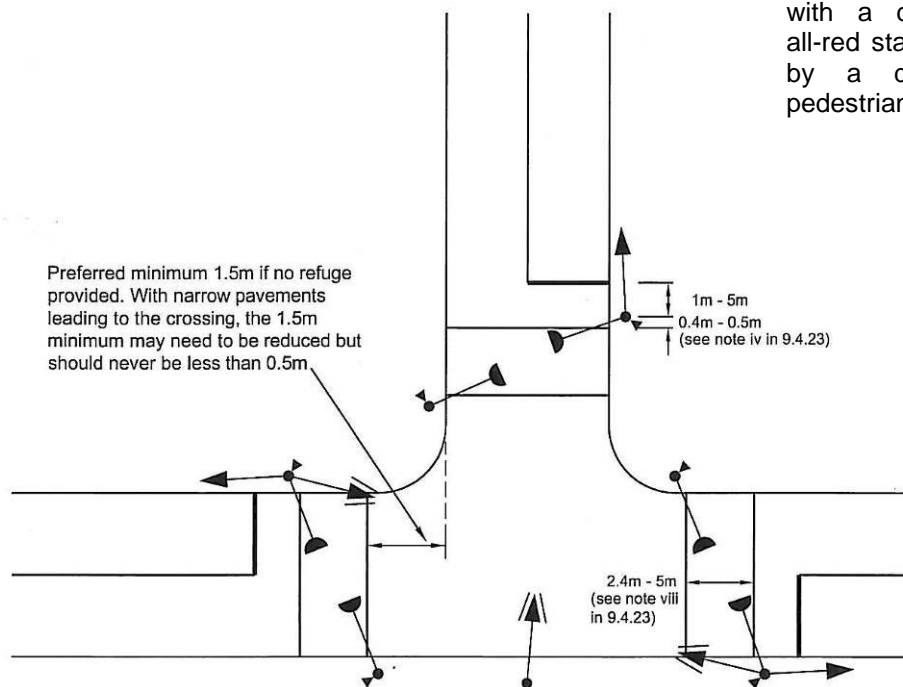

T-Junction with All-Red Demand-Dependent Pedestrian Stage

Figure 9E2

NOTES:

- Far-side secondary signals are sited on the major road refuges.
- As with the example in Figure 9E1, turning traffic has no special provision, and a demand-dependent all-red pedestrian stage is provided.
- Unequal demands during certain periods may require separate staging of opposing phases.

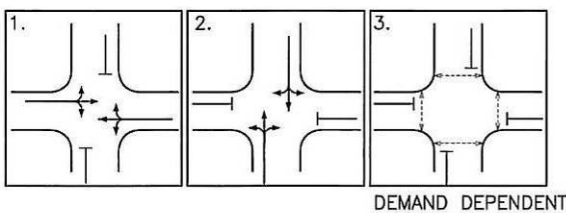
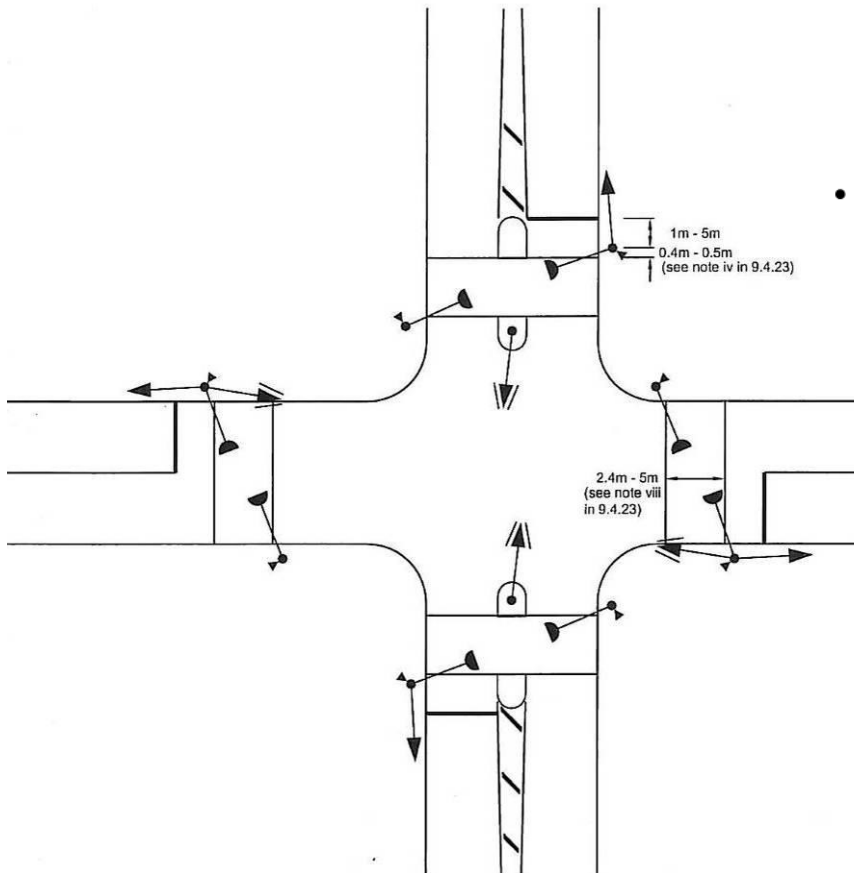

Alternative staging

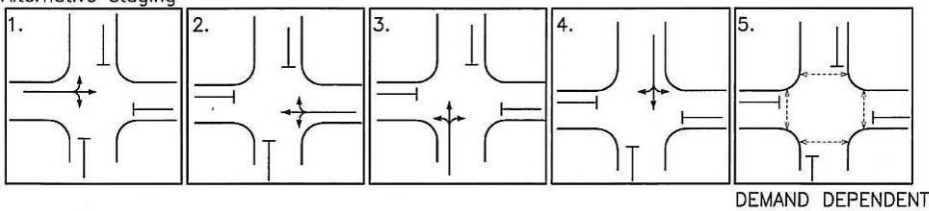

Major/Minor Junction with Central Islands on Main Road

Figure 9E3

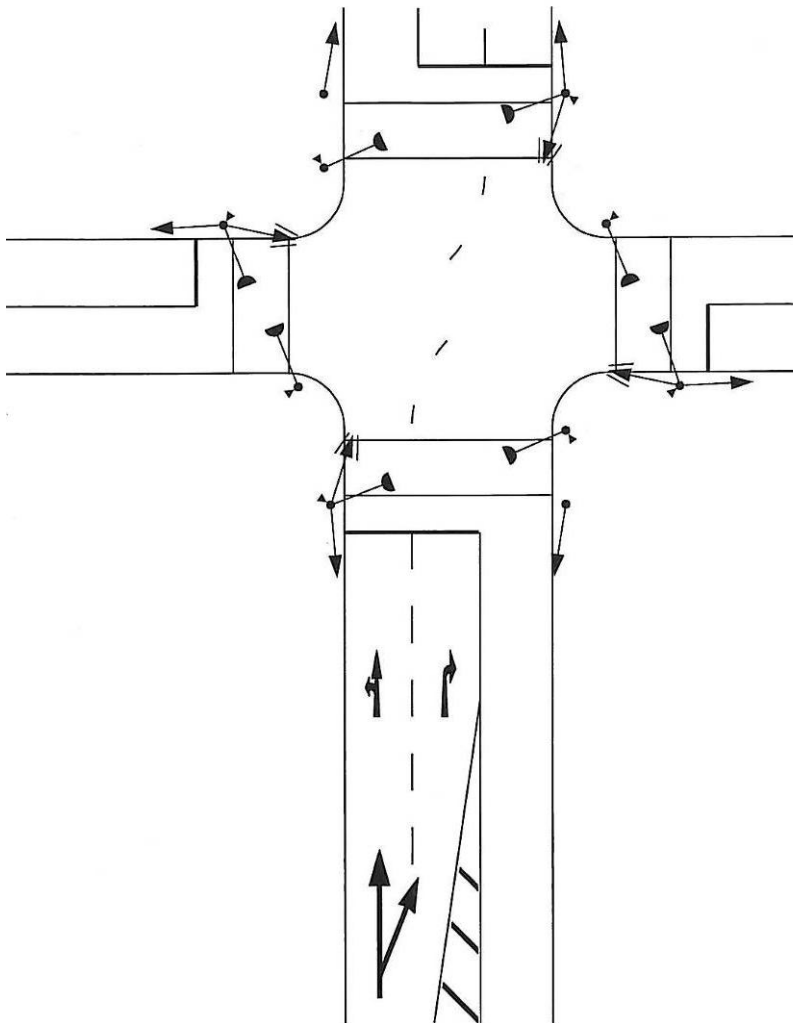

NOTES:

- The major road right turn lanes are opposite each other, which facilitates non-hooking turning movements during the major road phases.
- Lane markings to RRM 003B or RRM 003C (see Chapter 7) may be laid in the junction where guidance to traffic is considered necessary, but care should be taken to ensure that the meaning is clear to drivers on all approaches.
- Unequal demands during certain periods may require separate staging of opposing phases.

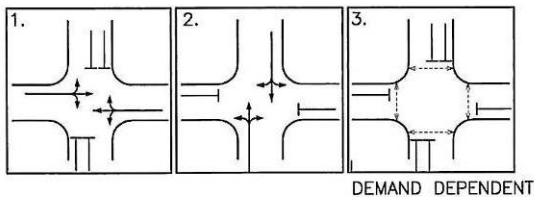

Alternative staging

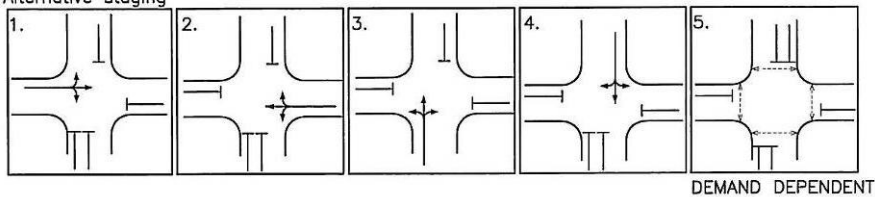

Major/Minor Junction without Central Islands

Figure 9E4

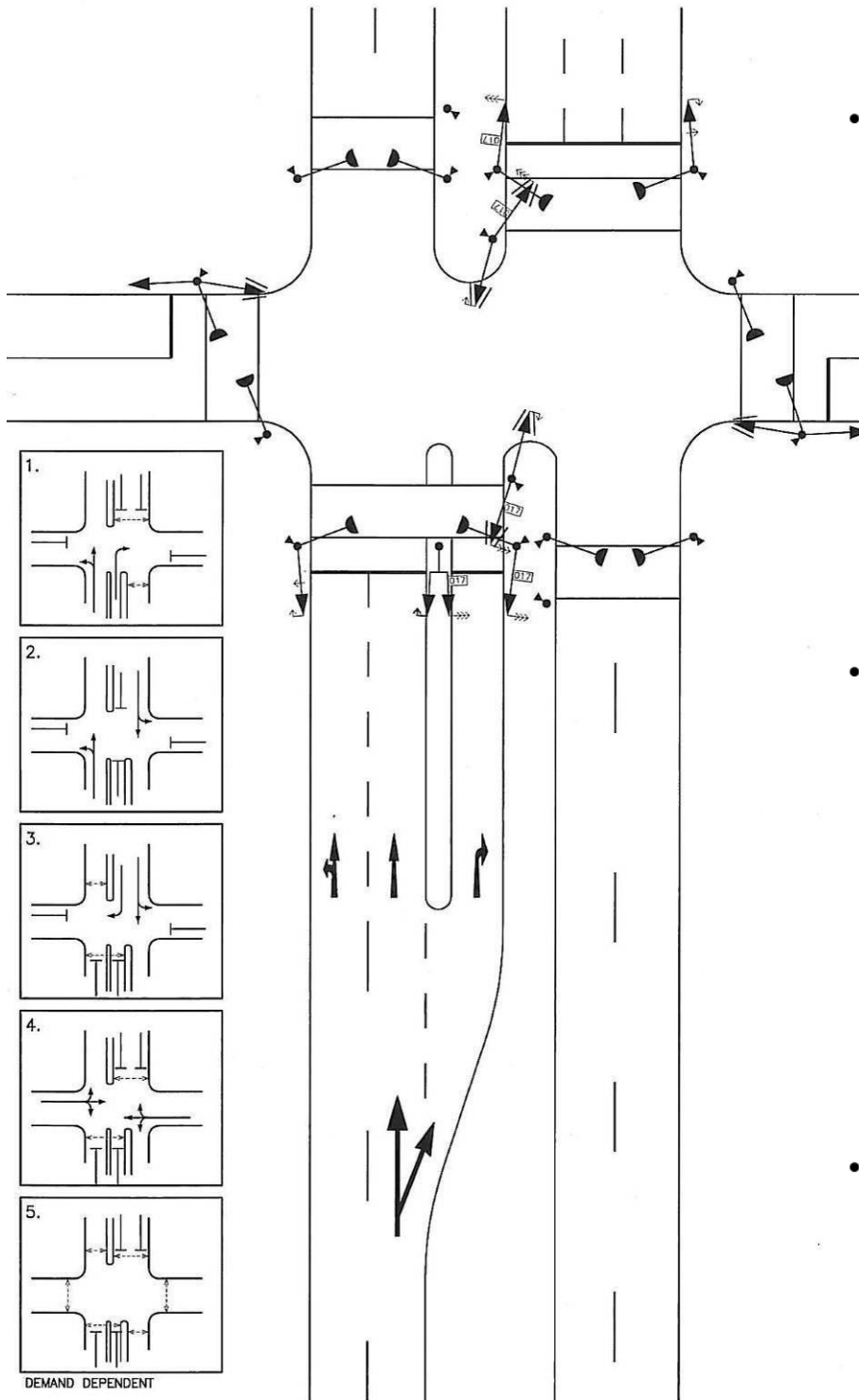

- NOTES:**
- Staggered pedestrian facilities have been provided across the major road due to the excessive crossing lengths that would otherwise apply, thus facilitating partial parallel pedestrian phasing. The all-red period would only need to be called by a pedestrian demand on the minor road. This layout provides enhanced flexibility for traffic, as it can cater for the variations in right-turn demands that may arise at various times of day.
 - It is important that drivers turning right from the main road into the side road complete their manoeuvre once they have entered the junction, as otherwise conflicts with cross flows would occur. It is therefore preferable that the secondary signals for these turns are not visible to drivers once they have crossed the stop line, and hence closely-associated secondary signals have been provided.
 - As pedestrians would be crossing the opposing carriageways simultaneously with the major road right turns, regulatory box signs with RUS 017 („No U-Turn“) have been specified.

Major/Minor Junction with Separate Right Turn Lanes on Main Road

Figure 9E5

NOTES:

- The major issues with staggered junction are blocking caused by tailing- back, and conflicting turning movements. Before a layout is designed every effort should be made to employ traffic management techniques to eliminate as many conflicts as possible.
- In general, staggered junctions should be treated as two separate T-junctions as shown in this and the following example. However, if doing so results in successive stop lines closer than 50m then the internal stop lines should be omitted and the whole area treated as a single junction. If the two staggered arms are less than 250m apart, local linking will be required.
- To address problems of blocking back on the section of road between the two side roads timings should be designed to minimise internal queuing.

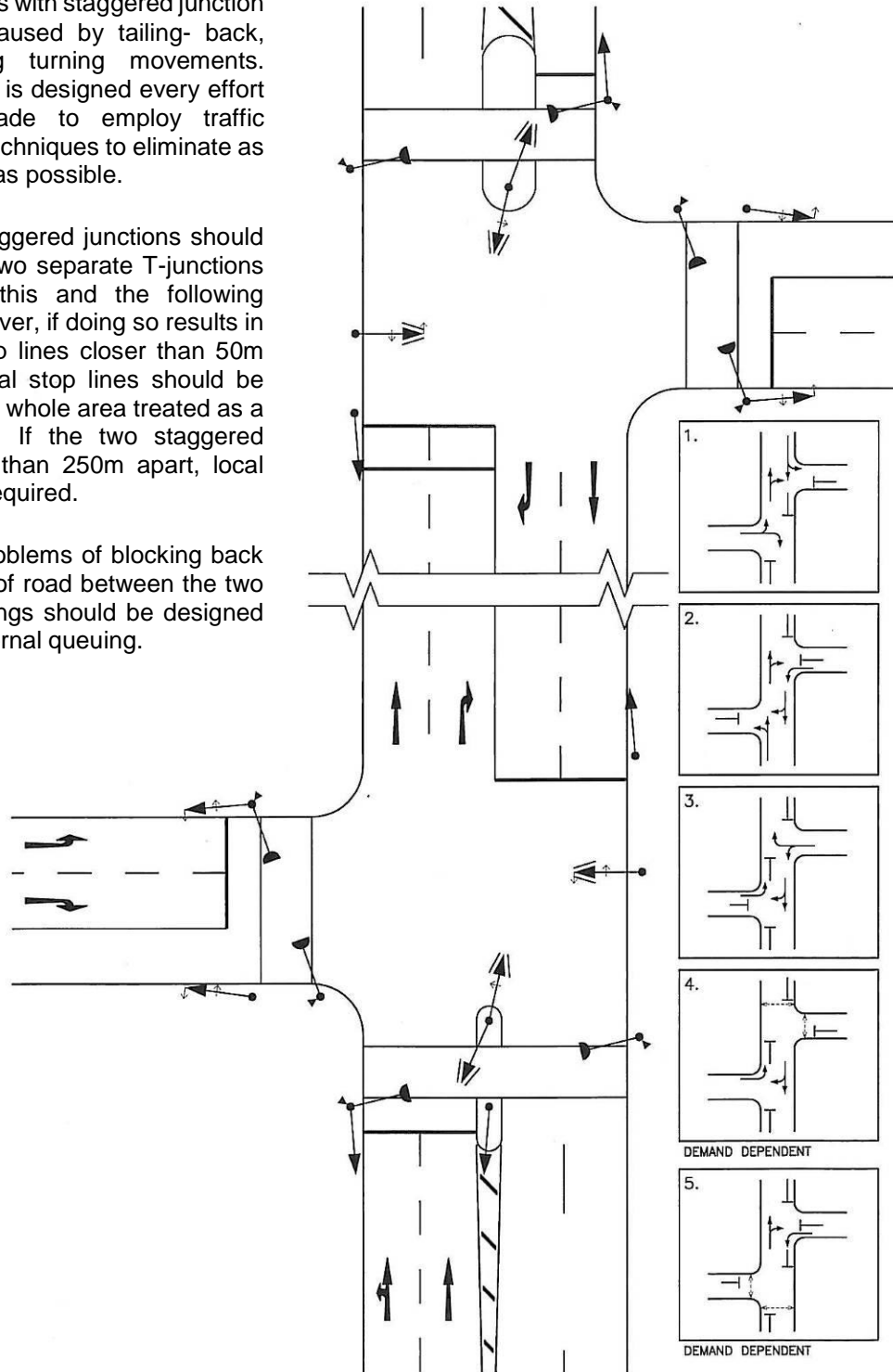

Left/Right Staggered Junction

Figure 9E6

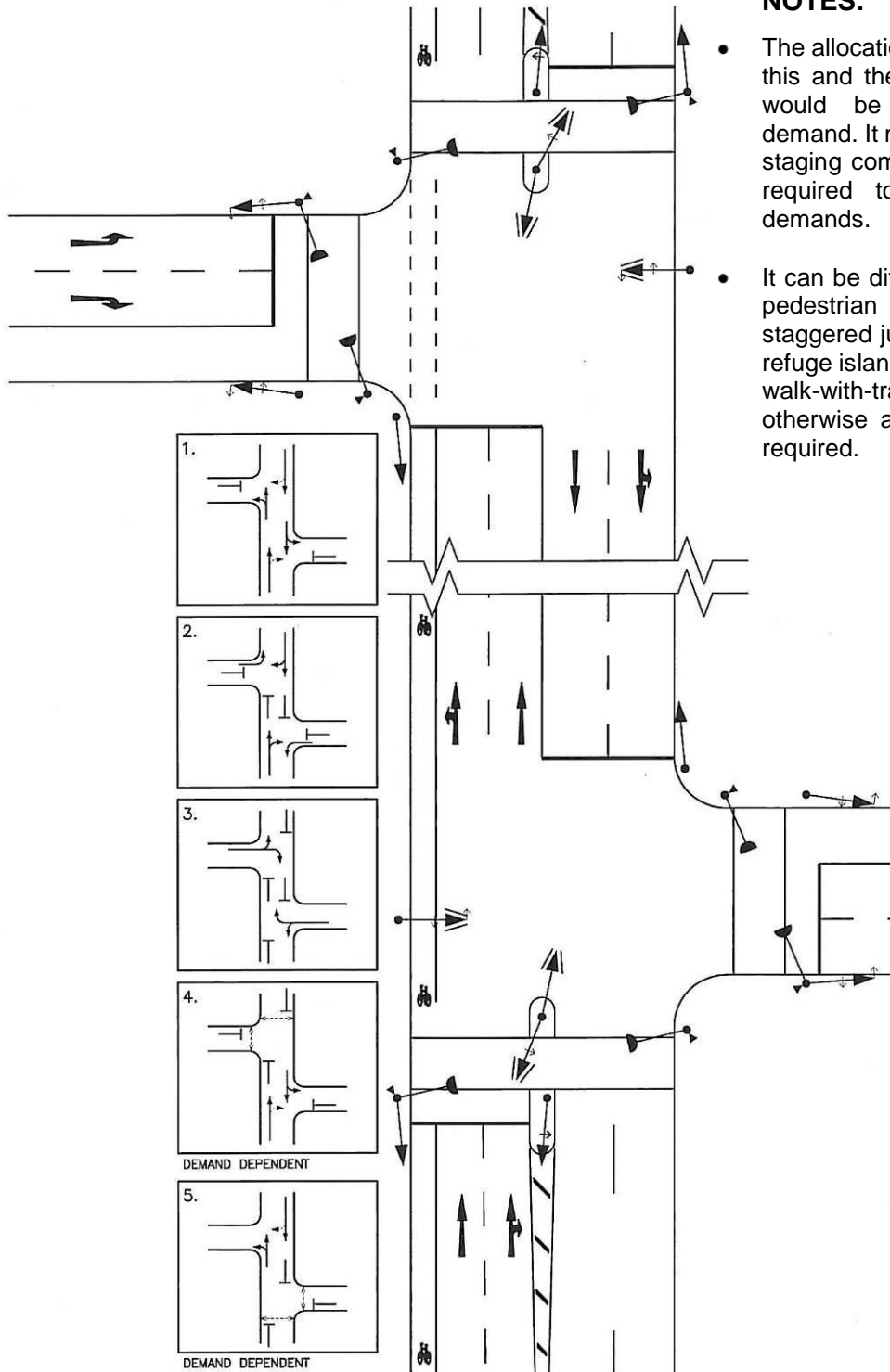

NOTES:

- The allocation of filter phases in this and the previous example would be dependent upon demand. It may be that different staging combinations would be required to cope with tidal demands.
- It can be difficult to incorporate pedestrian facilities within a staggered junction; provision of refuge islands can often allow a walk-with-traffic facility where otherwise an all-red would be required.

Right/Left Staggered Junction

Figure 9E7

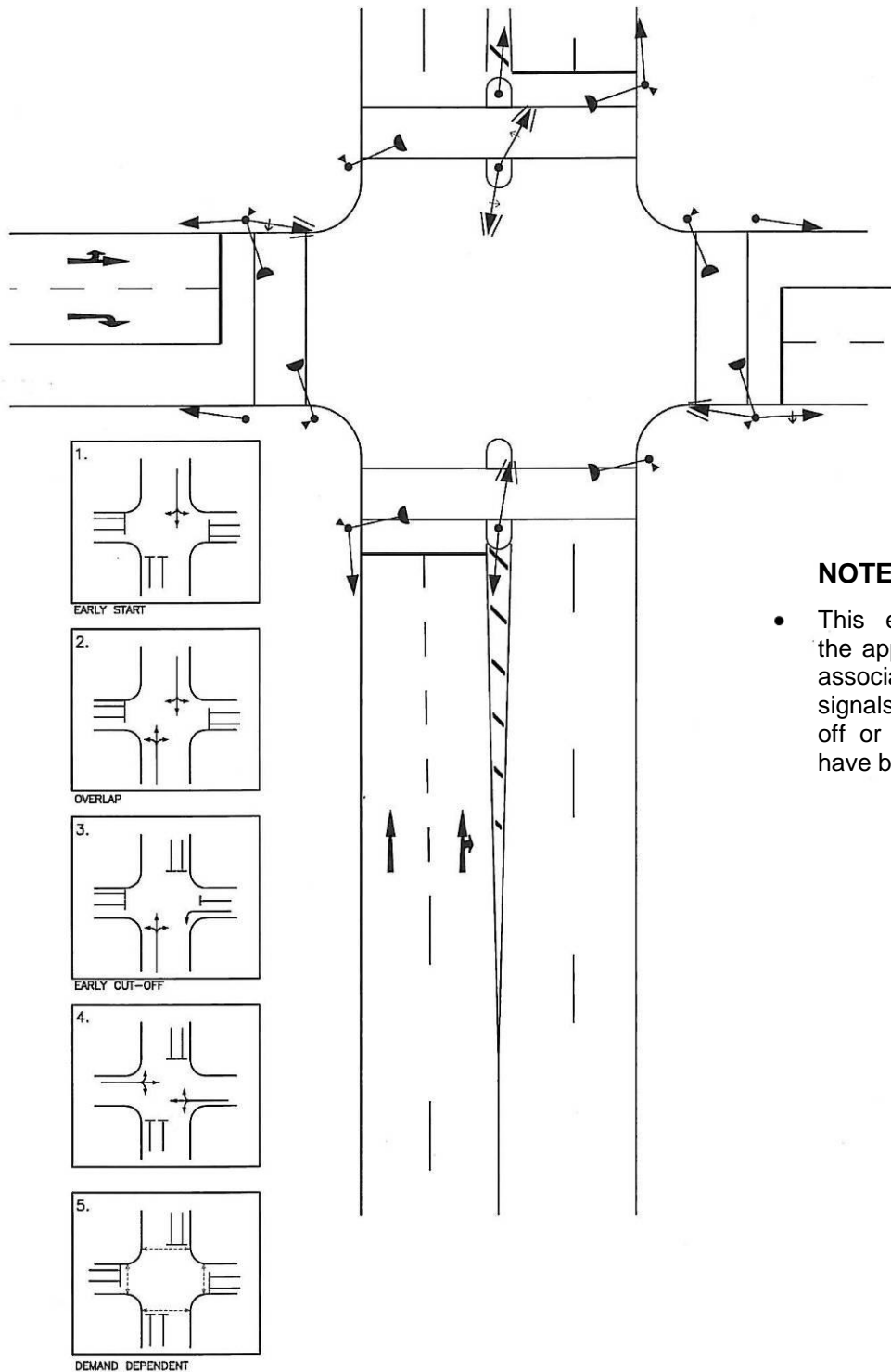

NOTES:

- This example illustrates the application of closely-associated secondary signals where early cut-off or early start phases have been specified.

Staging Arrangement for Early Start, Early Cut-Off and Filter

Figure 9E8

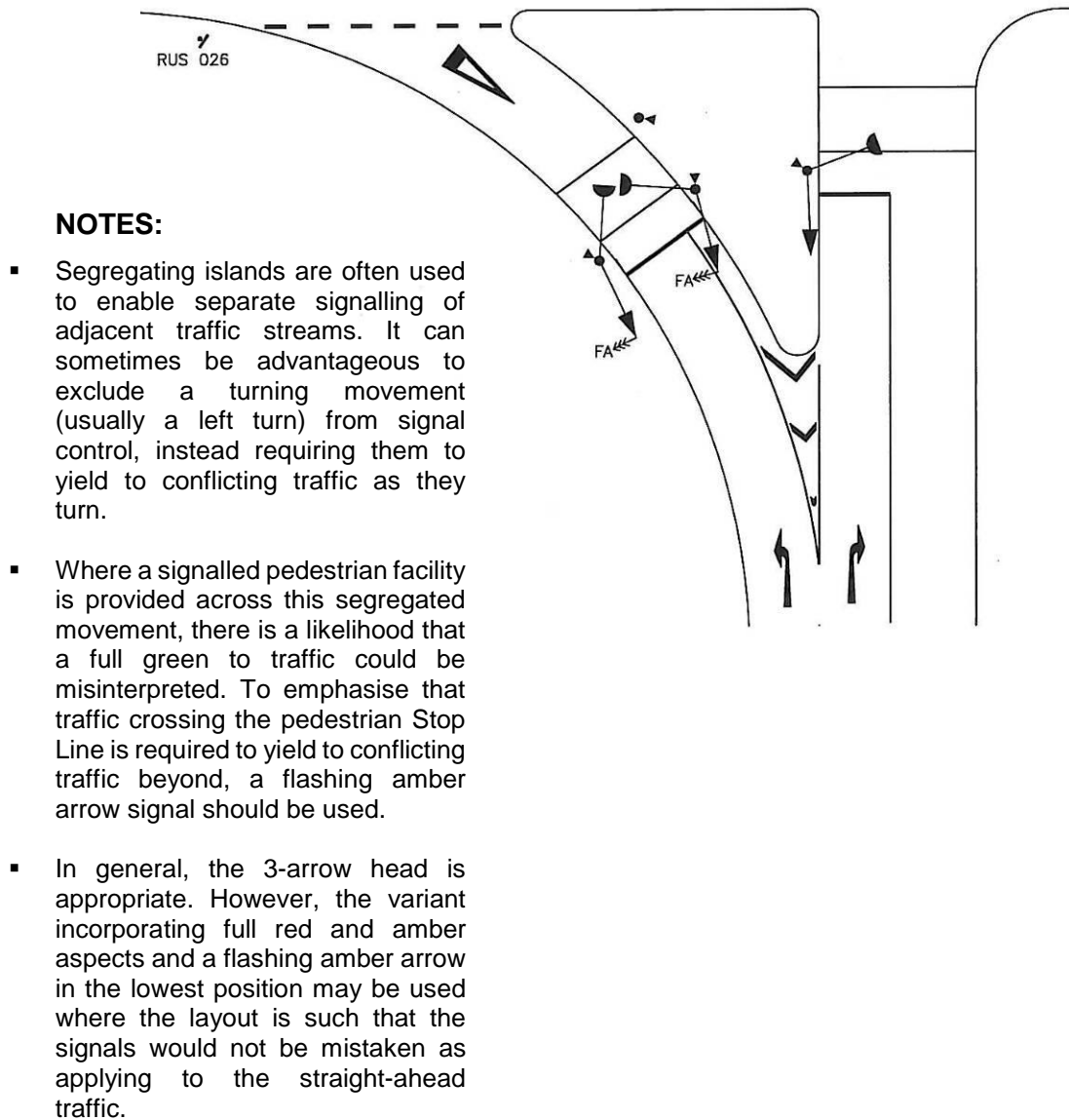

Uncontrolled Segregated Left Turn Lane

Figure 9E9

NOTES:

- The installation of traffic signals at roundabouts can improve capacity, balance queues between approaches, reduce vehicular speeds, improve safety (particularly for cyclists), provide controlled crossings for pedestrians and cyclists, and provide priority for public transport.
- Traffic signal control on roundabouts can be introduced on all approaches, or on only some of the approaches while the others operate on a yield basis.
- This illustration shows typical signalling on a roundabout entry. The additional secondary signal marked „A” may be required if the circulating carriageway is greater than two lanes.
- Secondary signals should be fitted with tunnel hoods to prevent drivers seeing conflicting signal indications.

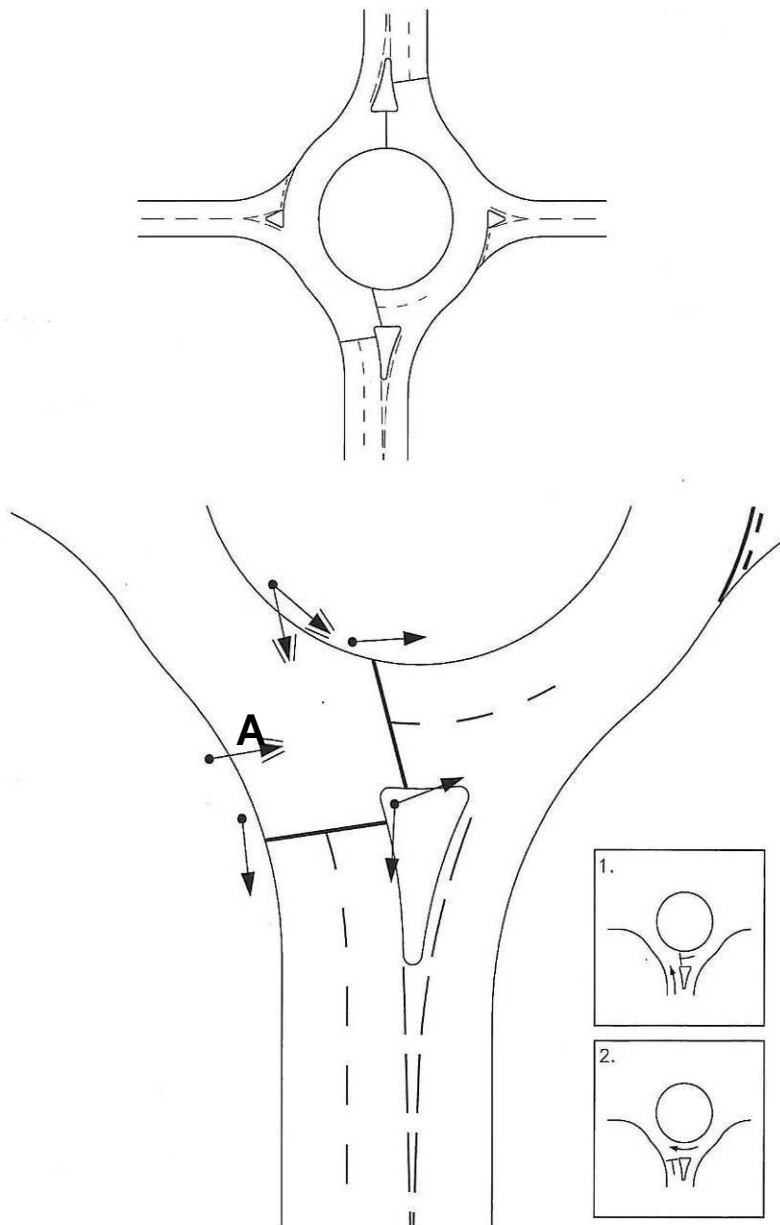

Signalised Roundabout Entry

Figure 9E10

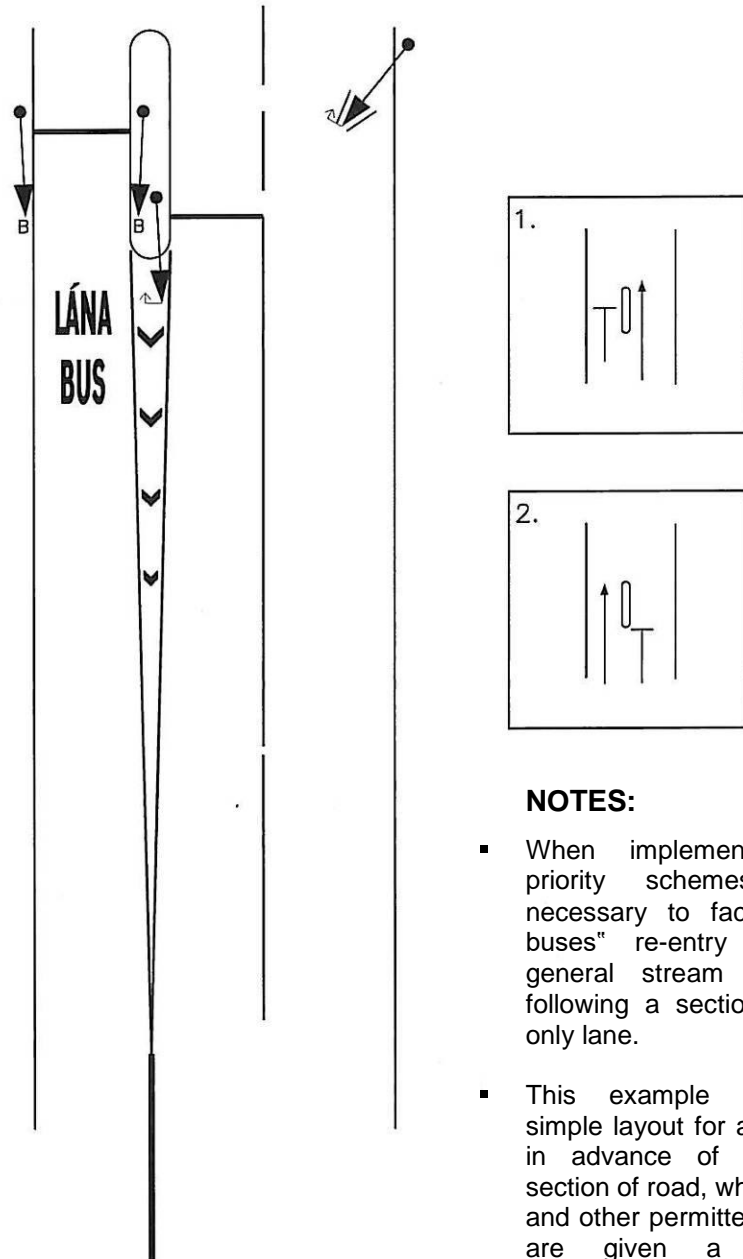

NOTES:

- When implementing bus priority schemes it is necessary to facilitate the buses' re-entry into the general stream of traffic following a section of bus-only lane.
- This example shows a simple layout for a bus gate in advance of a narrow section of road, where buses and other permitted vehicles are given a demand-dependent stage called up by detectors in the bus lane.

Bus Gate

Figure 9E11

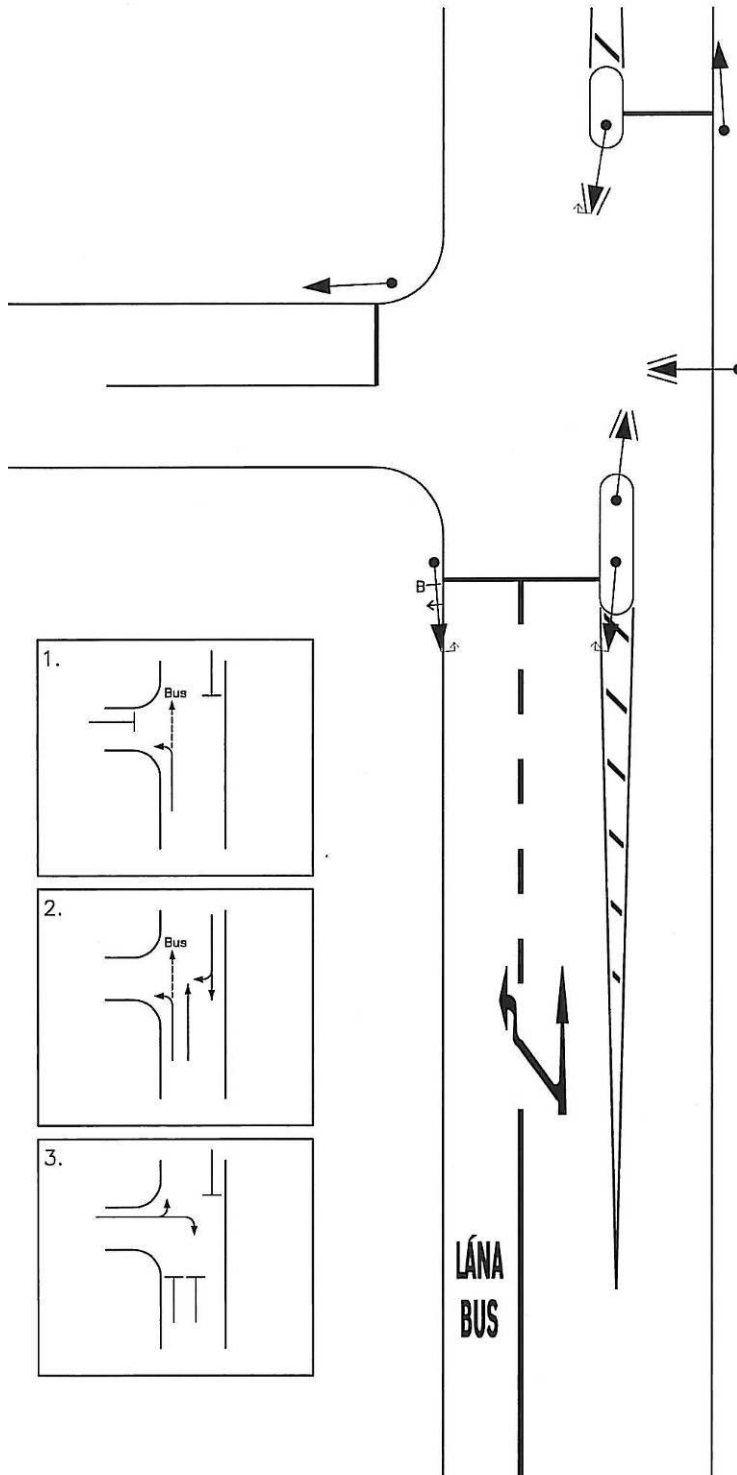

NOTES:

- Where a bus lane passes through a signal-controlled junction, early release of the bus may be impeded by left turning traffic at the junction.
- In this example use of the 5-aspect head RTS 013 permits the release of left turning traffic and ahead buses in advance of the ahead general traffic.

Bus Early Start at Signalised Junction

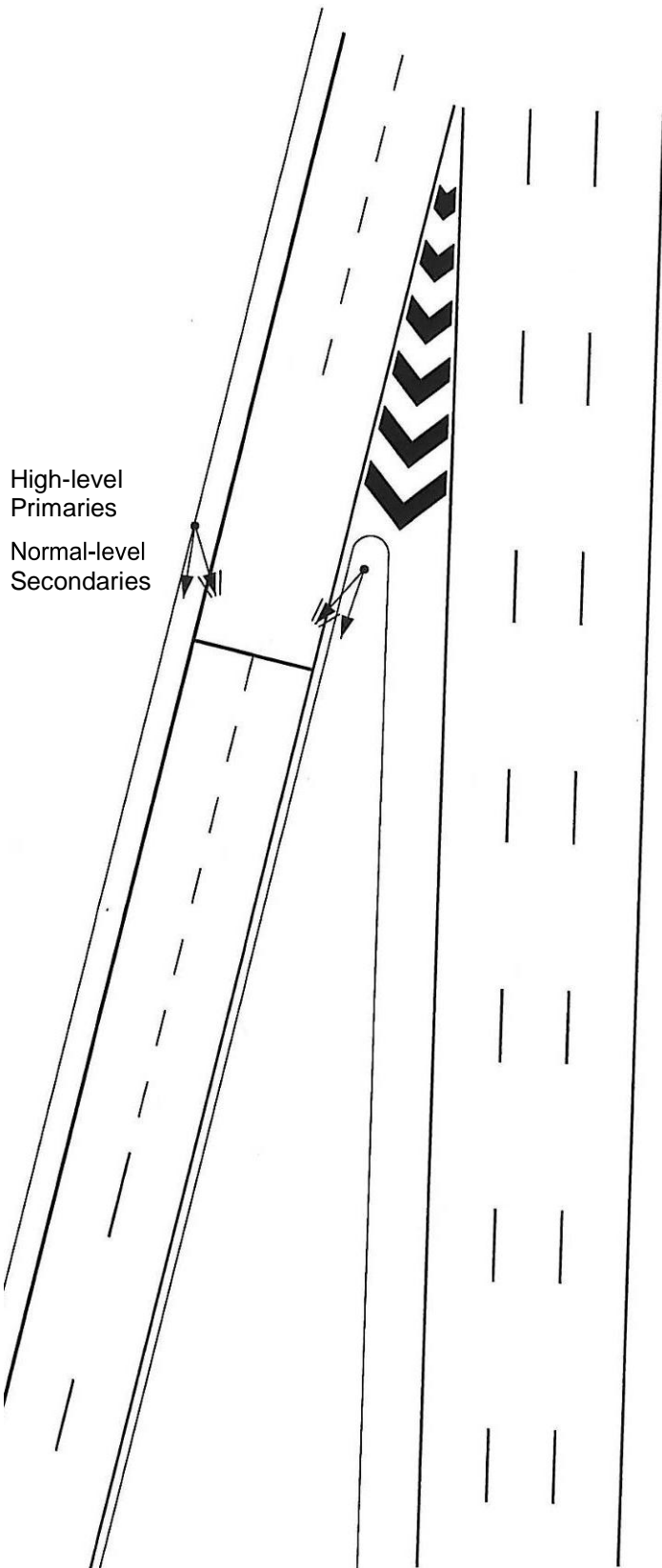

Figure 9E12

NOTES:

- Merge ramp metering may improve the flow of traffic on the main line carriageway of a motorway or high-speed dual carriageway in the vicinity of an entry merge, by regulating the entry flow of merging traffic. This can be useful in heavy traffic conditions to reduce congestion on the mainline road.
- Traffic signals for merge ramp metering must be accompanied by a Stop Line to indicate to drivers where they must stop when the red signal is displayed.
- Full aspect red, amber and green high-level primary signals shall be provided, either on high mast poles or mast arms on the slip road to control the rate at which vehicles on the on-slip join the main traffic. Secondary traffic signals shall be provided at normal mounting height on the same pole. These signals should be mounted approximately 5m beyond the associated Stop Line.
- The installation of merge ramp metering may be accompanied by traffic cameras to ensure drivers comply with the traffic signals.

Merge Ramp Metering

Figure 9E13

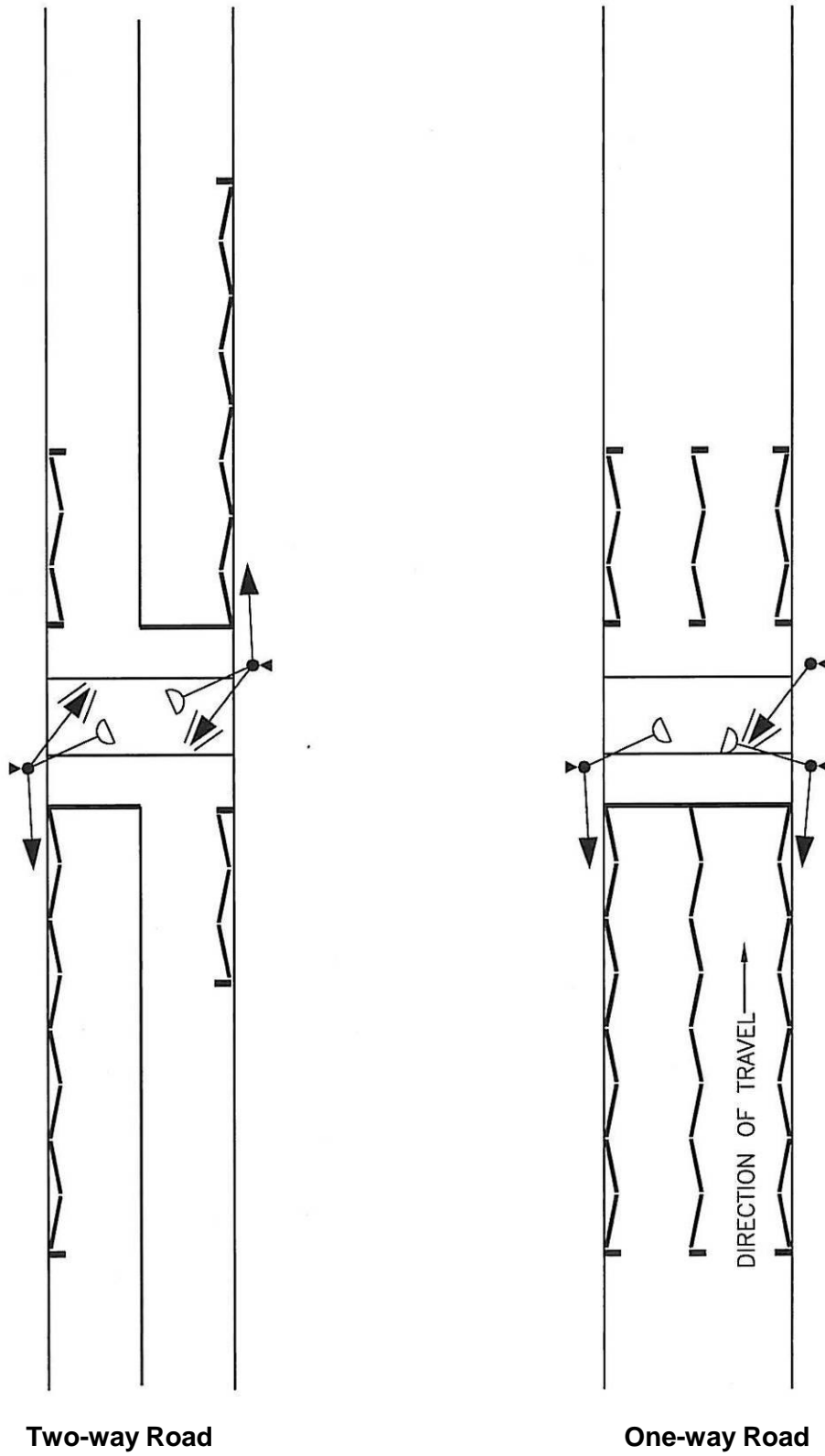

Pelican Crossings

Figure 9E14

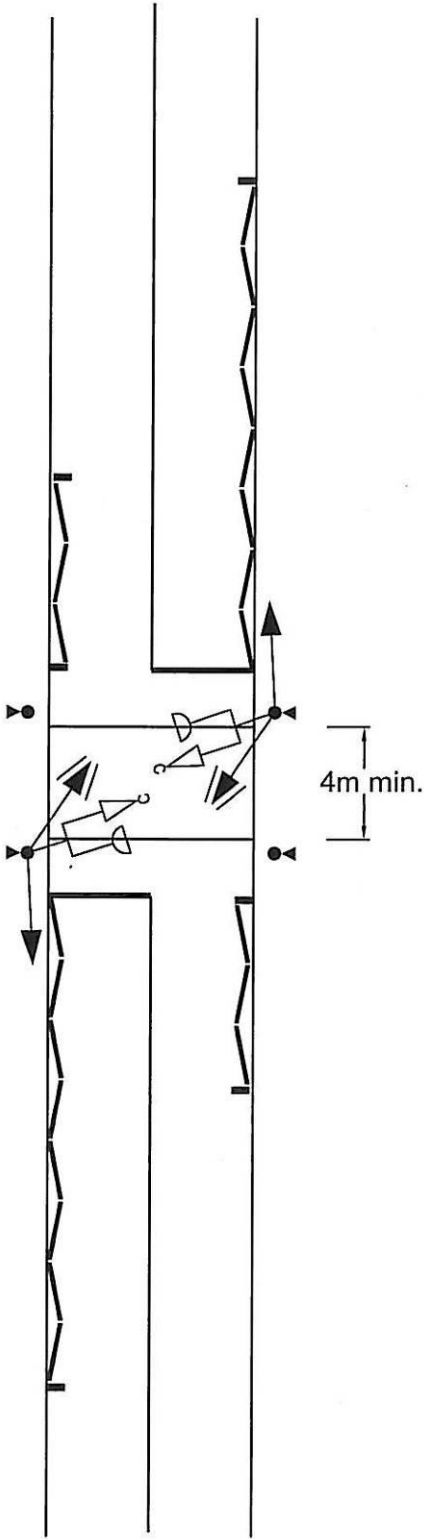

Toucan Crossing